

activity book

— THE — EXPRESS PICTURE DICTIONARY

for young learners



Elizabeth Gray



Express Publishing

THE
**EXPRESS PICTURE
DICTIONARY**

for young learners

activity book

Elizabeth Gray



Express Publishing

Published by Express Publishing

Liberty House, New Greenham Park, Newbury,
Berkshire RG19 6HW
Tel.: (0044) 1635 817 363
Fax: (0044) 1635 817 463
e-mail: inquiriesexpresspublishing.co.uk
<http://www.expresspublishing.co.uk>

© Elizabeth Gray, 2001

Design and Illustration © Express Publishing, 2001

Colour Illustrations: Terry Wilson, Chris, Pan

Music Compositions and Arrangement by Ted and Taz

All rights reserved. No part of this publication may be reproduced, stored in a retrieval system, or transmitted in any form, or by any means, electronic, photocopying or otherwise, without the prior written permission of the publishers.

First published 2001

ISBN 1-84216-610-7

Author's Acknowledgements

We would like to thank all the staff at Express Publishing who have contributed their skills to providing this book. Thanks are due in particular to: Anne Ellis (Editor in Chief), Catherine Smith and Debbie Wilson (senior editors), Richard White (senior production controller), the Express design team and David Smith, Kimberly Baker and Eric Taylor for their support and patience. We would also like to thank these institutions and teachers who piloted the manuscript, and whose comments and feedback were invaluable in the production of the book.

While every effort has been made to trace all the copyright holders, if any have been inadvertently overlooked the publishers will be pleased to make the necessary arrangements at the first opportunity.

Contents

THE BASICS:	The Alphabet.....	6
	Numbers.....	8
	Colours.....	10
PEOPLE:	Describing People.....	12
	The Body.....	14
	Clothes I.....	16
	Clothes II.....	18
	Ben and Vicky's Family.....	20
HOME:	On the Outside.....	22
	In the Inside I.....	24
	In the Inside II.....	26
	In the Garden.....	28
FOOD:	At the Supermarket.....	30
	In the Kitchen.....	32
	A Party.....	34
TIME:	What's the time?.....	36
	Days and Dates.....	38
	The Year.....	40
SCHOOL:	My School.....	42
	Ben's Classroom.....	44
	In the Computer Room.....	46
	In the Music Room.....	48
	Jobs.....	50
ACTIVITIES:	Indoor Hobbies.....	52
	At the Park.....	54
	At the Sports Centre.....	56
	At the Stadium.....	58
	Outdoor Activities.....	60

ANIMALS:

Pets	62
On the Farm.....	64
At the Zoo.....	66
Marine World.....	68

OUR WORLD

The Weather.....	70
The Earth.....	72
The Landscape.....	74
The Solar System.....	76

OUR TOWN:

Transport.....	78
On the Road.....	80
Main Street.....	82
In a Shopping Centre.....	84
At the Clinic.....	86

WORDS

Opposites.....	88
At the Playground.....	90
In the Maze.....	92
A Summer Camp.....	94
A School Fair.....	96

FUN:

At the Beach.....	98
Leisure Time.....	100
Home Entertainment.....	102
Fairy Tales.....	104

TEST YOUR VOCABULARY.....	106
---------------------------	-----

THE BASICS: THE ALPHABET

A Circle the odd letter.

1 a a a <u>u</u> a	4 d d d d b	7 m n m m m
2 b q b b b	5 l l l l l	8 r n n n n
3 n h n n n	6 q p q q q	9 c e c c c

B Write in small letters.

- 1 LAMB _ _ _ _ _
- 2 UMBRELLA _ _ _ _ _
- 3 APPLE _ _ _ _ _
- 4 DOLL _ _ _ _ _
- 5 VAN _ _ _ _





C Write in capital letters.

- 1 watch _ _ _ _ _
- 2 igloo _ _ _ _ _
- 3 queen _ _ _ _ _
- 4 train _ _ _ _ _
- 5 yacht _ _ _ _ _

D Match the letters.

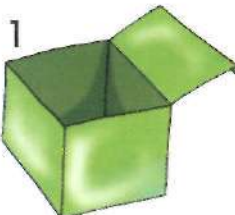
A d q D M Y x
 f B F b Q y X m

E Complete the words and draw lines to match them with the pictures.

1 	2 	3 	4 	5 
---	---	--	---	---

- 6 f r _ g _ a t _ a m b o _ s _ a r



Can you find 8 words in the wordsearch?

E G G P Q X O N
 A L D B M A N E
 C A T A D E I T
 F S K L I Z O O
 G S H L J L N M



Complete the puzzle.

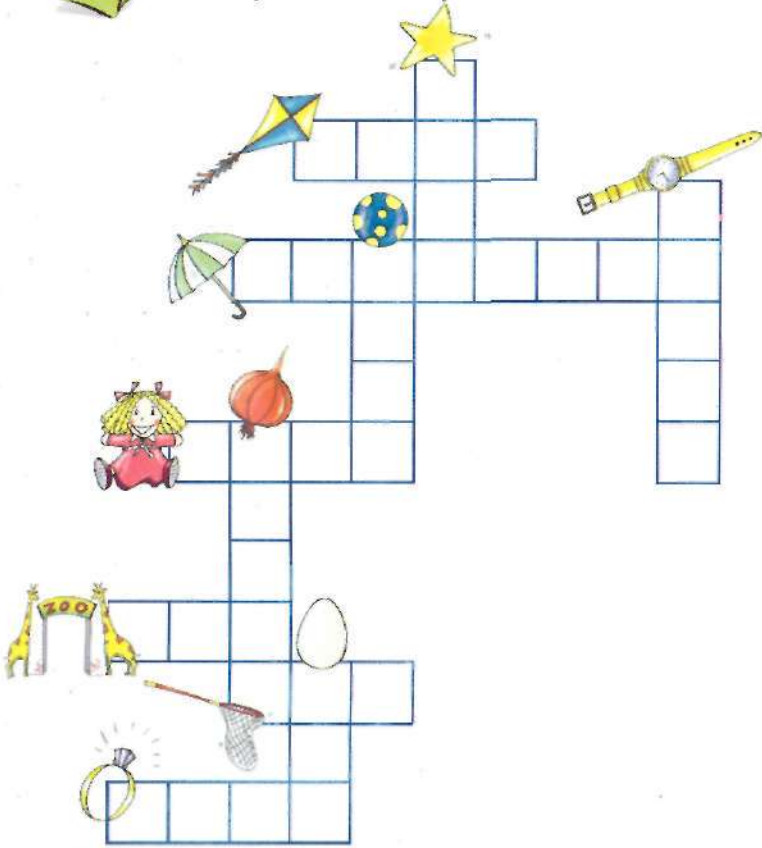

Unscramble and stick.

1 ycaht _____



2 ratin _____

3 ablm _____



4 nma _____

5 salsg _____

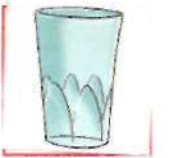

6 itke _____



Listen and write the words.

- 1 _____
- 2 _____
- 3 _____
- 4 _____
- 5 _____

- 6 _____
- 7 _____
- 8 _____
- 9 _____
- 10 _____



A Complete the countdown!



ten

 eight

 five

 two

 Go!

B Join the dots. What is it?

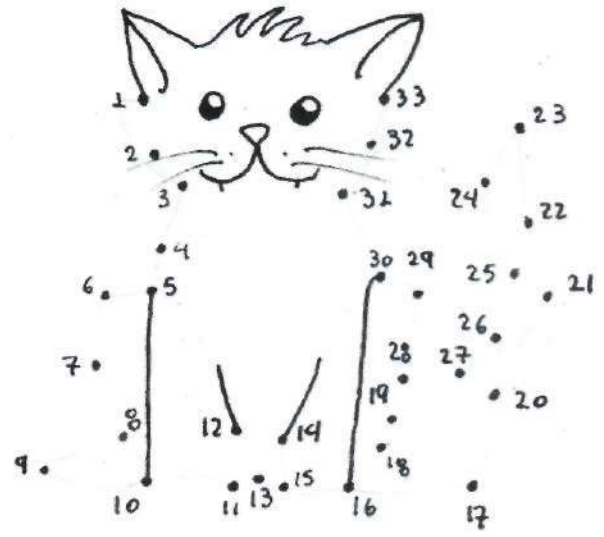

It's a _____!

C Count and colour

the fourth egg

the eighth star

the fifth box

the seventh apple

the third umbrella

the first onion

the sixth kite

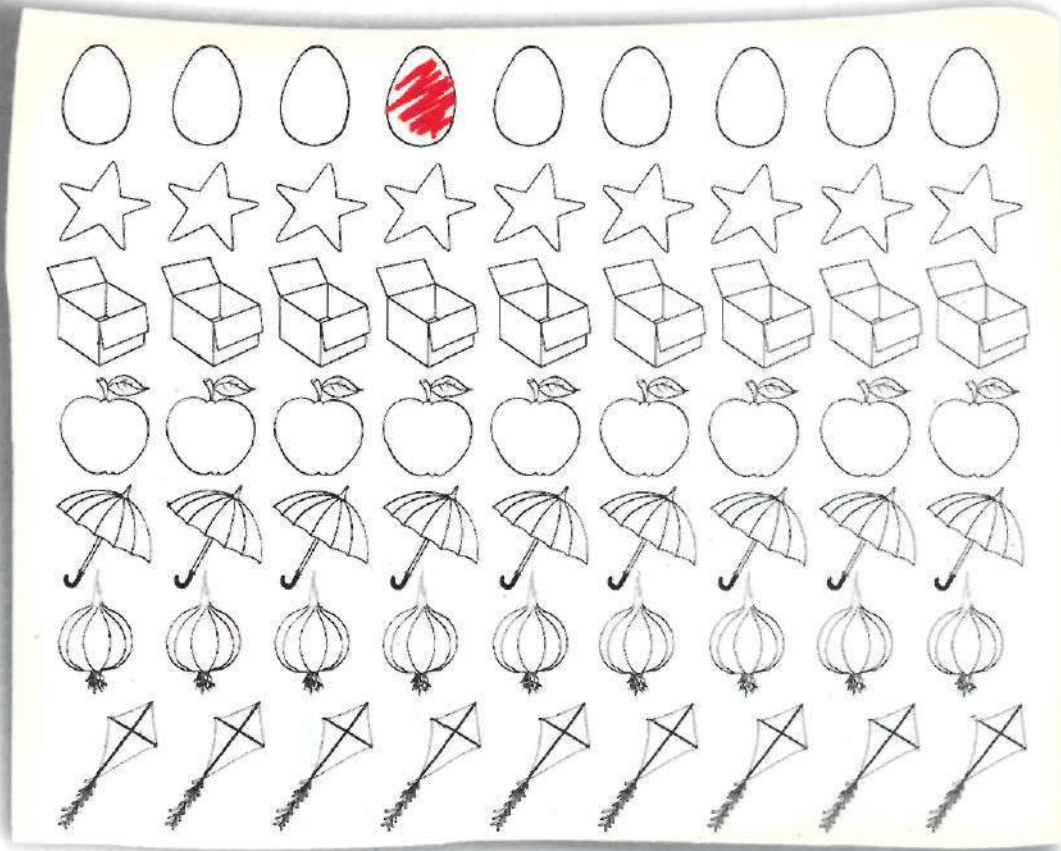



Draw lines to match the words with the numbers. Which numbers are odd? Which are even?

30 sixty 20 five eighty thirty
 80 fifty 50 11 seventy
 forty 5 twenty eleven 40
 100 3 7 >0 three a hundred
 seven

(A red arrow points from 'sixty' to '60')



Do the sums!

1 + 3 = 4 one plus three equals four

2 x 3 = 6 two times three equals six

7 + 2 = _____

4 x 2 = _____

4 - 2 = 2 four minus two equals two

5 x 5 = _____

5 - 3 = _____

6 ÷ 2 = 3 six divided by two equals three

13 - 6 = _____

8 ÷ 4 = _____



Play Bingo! Circle six numbers on your bingo card. Then listen. If you hear any of your circled numbers, cross them out. The first student to cross out all of his/her numbers shouts "Bingo!" and is the winner.

7	12	29	72	17	89	28
1	15	54	100	37	48	92
80	39	22	14	31	43	75
26	3	30	81	70	20	13
18	63	68	90	23	25	50



THE BASICS: COLOURS

A Read and colour.

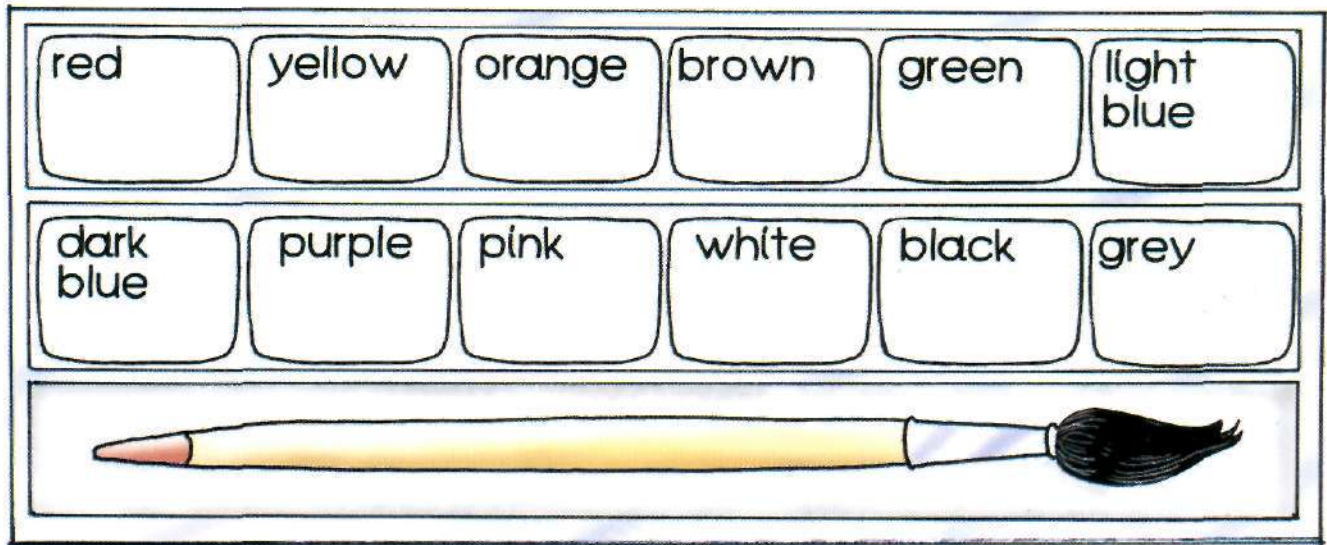

B Draw and colour.

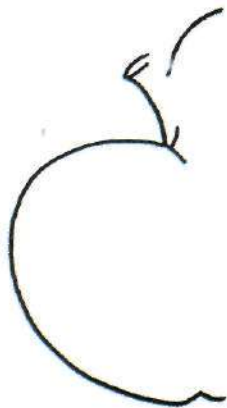

a green apple

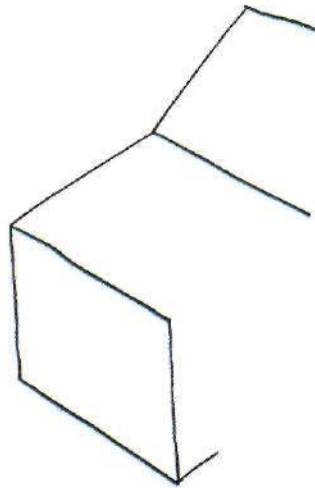

a purple box



a light blue umbrella

C Look at the picture on pages 10-11 in the dictionary. Find these things and write what colour they are.

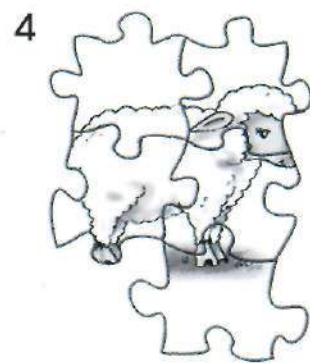
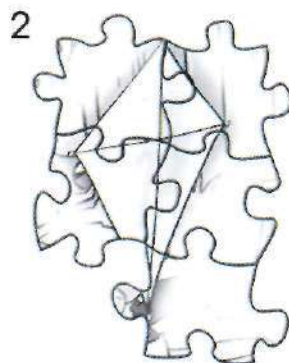
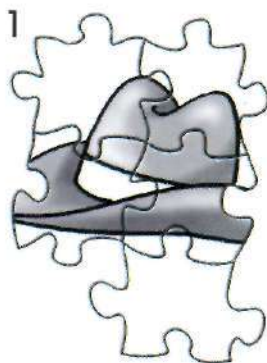



Colour the picture. Then complete the sentences.

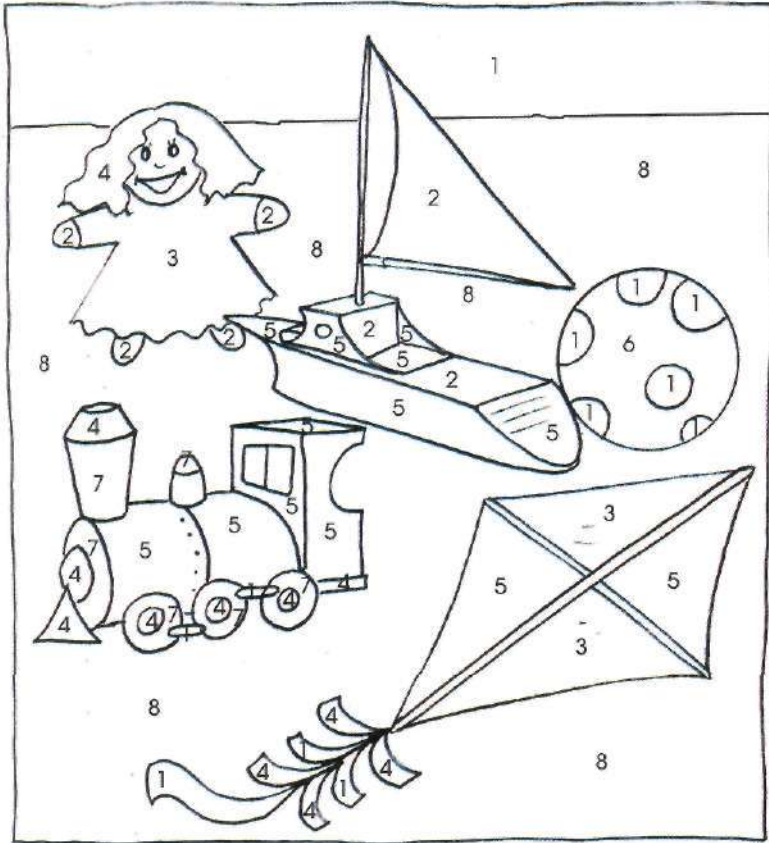

- 1 The ball is purple and yellow.
- 2 The doll _____
- 3 The boat _____
- 4 The train _____
- 5 The kite _____

- | | |
|------------|------------|
| 1 = yellow | 5 = blue |
| 2 = white | 6 = purple |
| 3 = pink | 7 = black |
| 4 = red | 8 = green |



Listen and complete the notes about these children.

1

name: _____

age: _____

favourite colour: _____

2

name: _____

age: _____

favourite colour: _____



Now, talk to your friends and write.

1

name: _____

age: _____

favourite colour: _____

2

name: _____

age: _____

favourite colour: _____



PEOPLE: DESCRIBING PEOPLE

A Look at the pictures and letters and write the words.

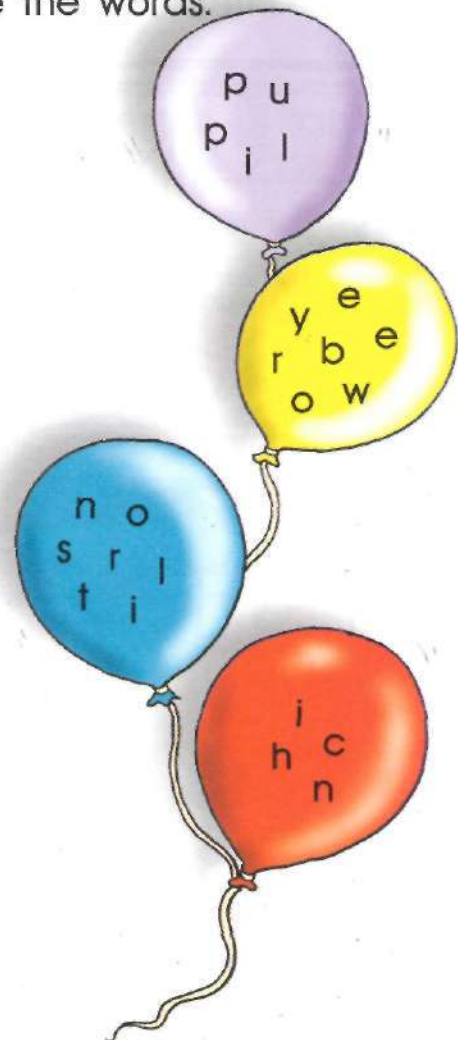
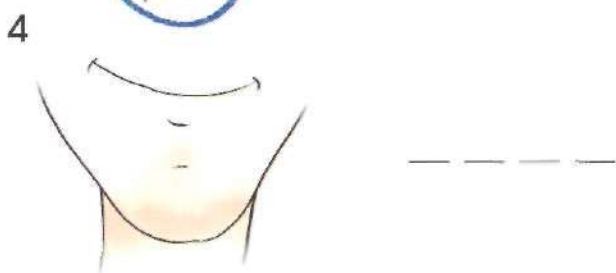
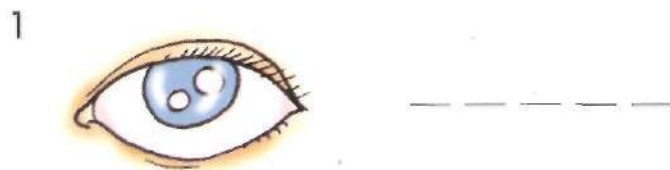

B Look at the picture and fill in the words.



Hello! I'm Wacky, the monster. My f _____ is green. I've got short red h _____, three e _____, a big n _____ and two big e _____

How about you?

C Now, draw a picture of your face and write sentences.

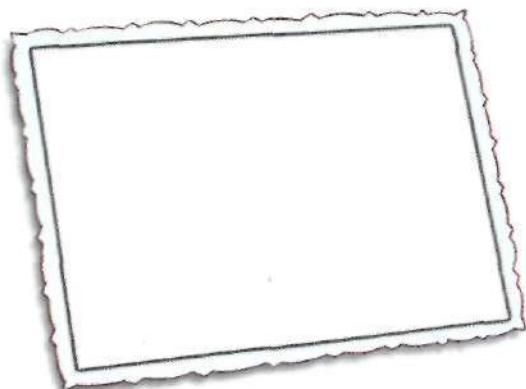

Hello! I'm _____. My _____ is _____. I've got _____ and _____.



Listen and write a number.

A



B



C





Can you find 8 words in the wordsearch?



Use stickers to create your own monster.

O	C	H	E	E	K	O	N	A
B	T	T	L	P	U	P	I	L
N	M	C	T	U	P	H	A	T
M	O	U	S	T	A	C	H	E
F	U	E	B	E	M	U	I	E
G	T	O	E	E	L	R	I	T
C	H	E	A	S	I	L	G	H
K	W	A	R	A	R	Y	L	E
L	W	H	D	O	J	A	W	T

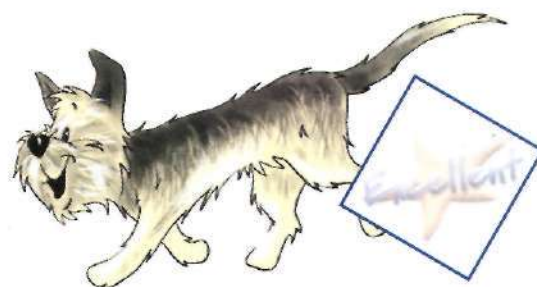
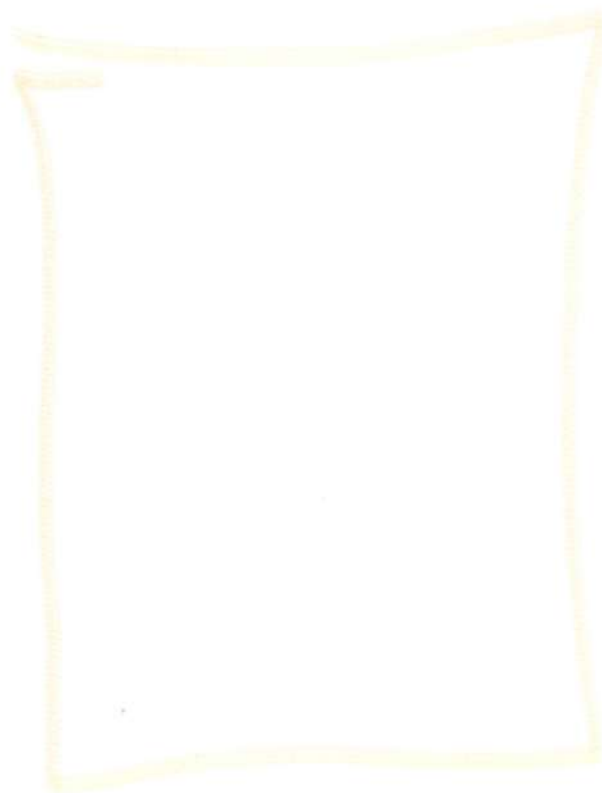

PEOPLE: THE BODY

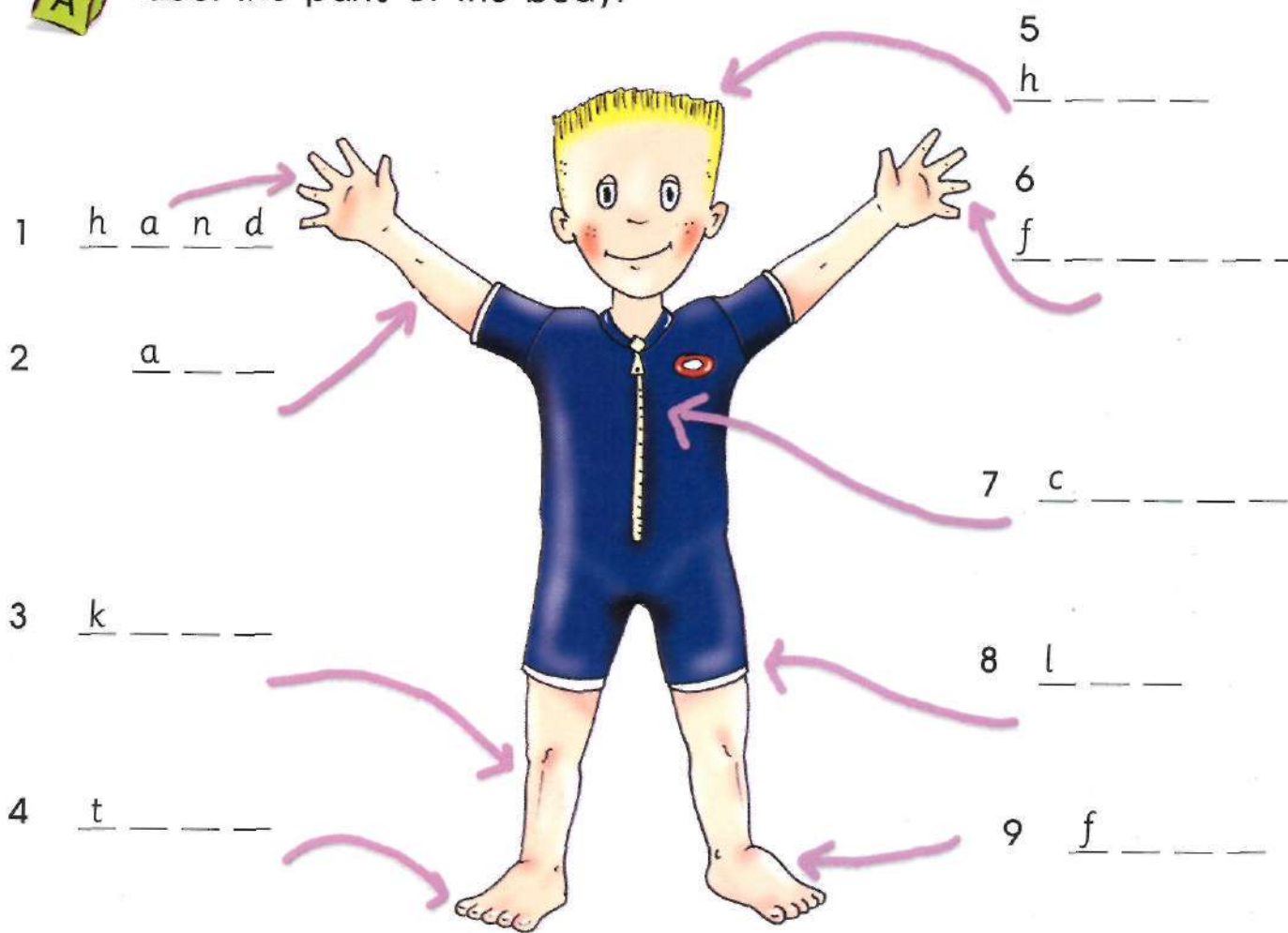

A Label the parts of the body.

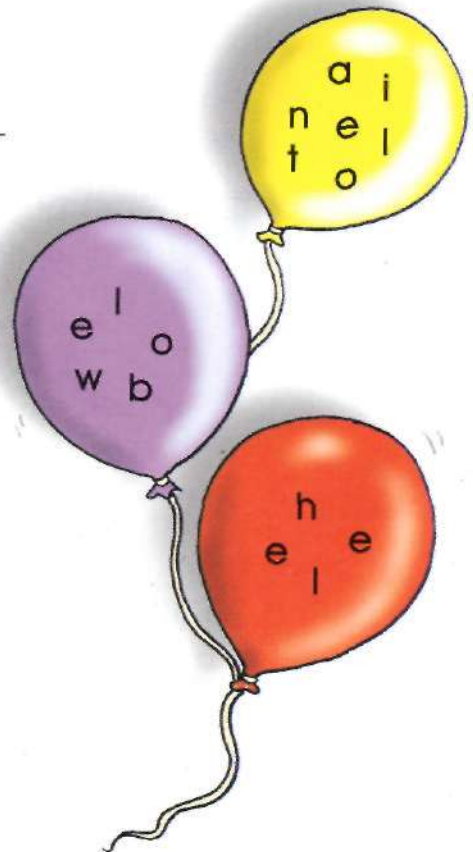
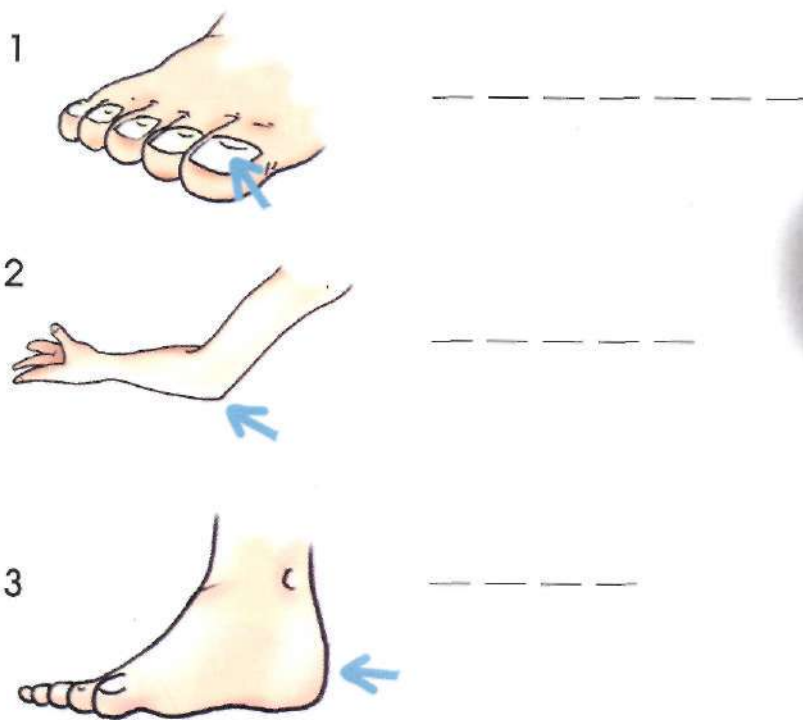

B Look at the pictures and letters and write the words.

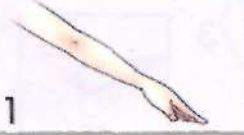

C Put the words in the correct list.

neck	arm	foot			
toes	armpit	wrist	1	2	3
palm	shoulder	calf	_____	_____	armpit
shin	chest	fingers	_____	_____	_____
			_____	_____	_____
			_____	_____	_____

D Can you find 13 words in the wordsearch?

A D F G K F **T H I G H** O
 L P Z W R I H G I S C R
 G H C G K N U C K L E S
 B A C K A G M A T M S T
 R T H P S E B L E G H O
 I O E A A R H F O O O M
 I R S H I N T I R A U A
 N S T E P A L M S I L C
 T O E T N I A P I E D H
 P E A N K L E B T N E G
 E H G L E A S D K I R S

E Read and circle.

- How many eyes have 3 people got?
A sixty B six
- How many legs have 6 people got?
A twelve B twenty
- How many fingernails have 4 people got?
A fourteen B forty
- How many shoulders have 5 people got?
A five B ten
- How many wrists have 2 people got?
A four B eight

F Look at the picture. Write about Wacky the monster.



Hello again! Look at me! I've got

2 _____, 4 _____,

3 _____ and 2 _____.



PEOPLE: CLOTHES I

A Read and stick.



boots



hat



glasses



necklace



handbag

B Draw lines to match the words with the pictures.

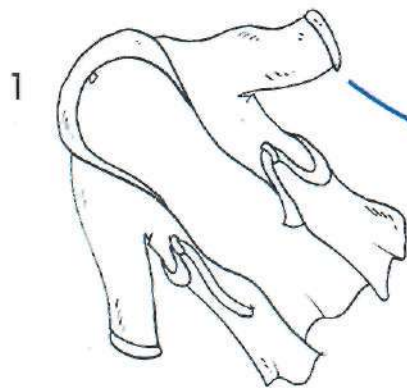

blouse
dressing gown
suit
shirt
dress
tie

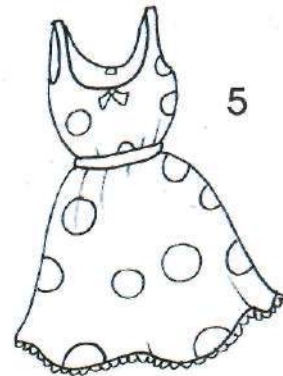
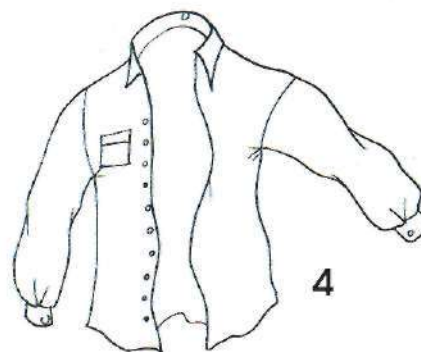
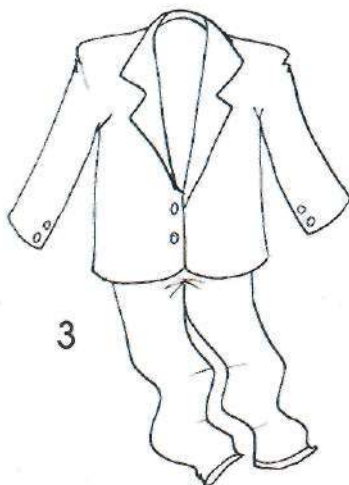
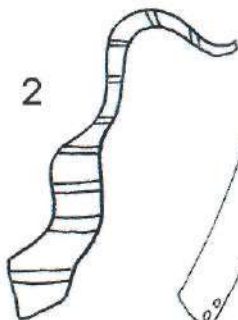
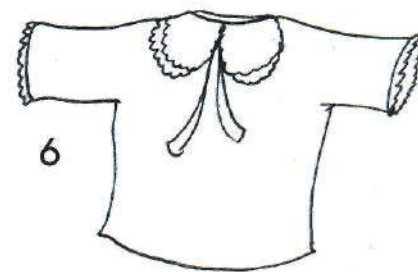

C Now, read and colour the clothes in B.

1 The blouse is green.

2 The tie is blue and red.

3 The suit is grey.

4 The dress is purple and yellow.

5 The shirt is pink.

6 The dressing gown is yellow.

D What are these? Write the words.

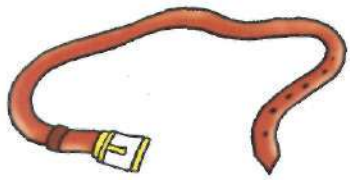

1 b e l t

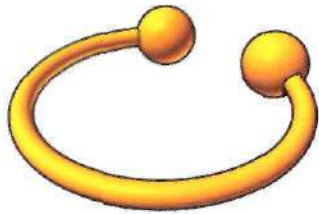

2 _____



3 _____



4 _____

E Put the words in the box in the correct list.

dress	jacket	suit
tie	skirt	hat
blouse	handbag	



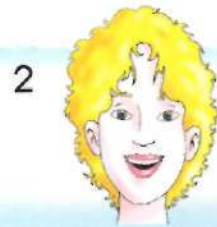

F Look at the pictures and write.



She's wearing a brown _____ and a yellow _____.



He is wearing a grey pair of _____, a light blue _____, and a pair of black _____.



PEOPLE: CLOTHES II



Look at these clothes. Which are Vicky's? Which are Ben's? Draw lines.



Now, listen and colour Ben and Vicky's clothes.



Read and circle.



1 It's a pair of gloves.

Yes/No

2 It's a pair of boots.

Yes/No

3 It's a T-shirt.

Yes/No

4 It's a pair of trainers.

Yes/No

5 It's a tracksuit.

Yes/No

D Look at the pictures and letters and write the words.

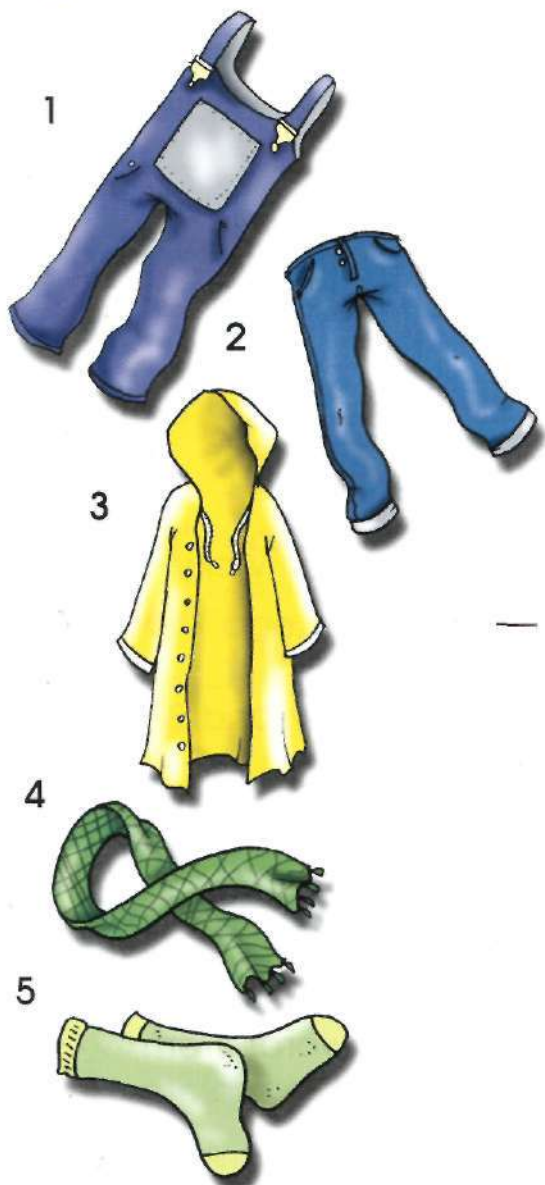

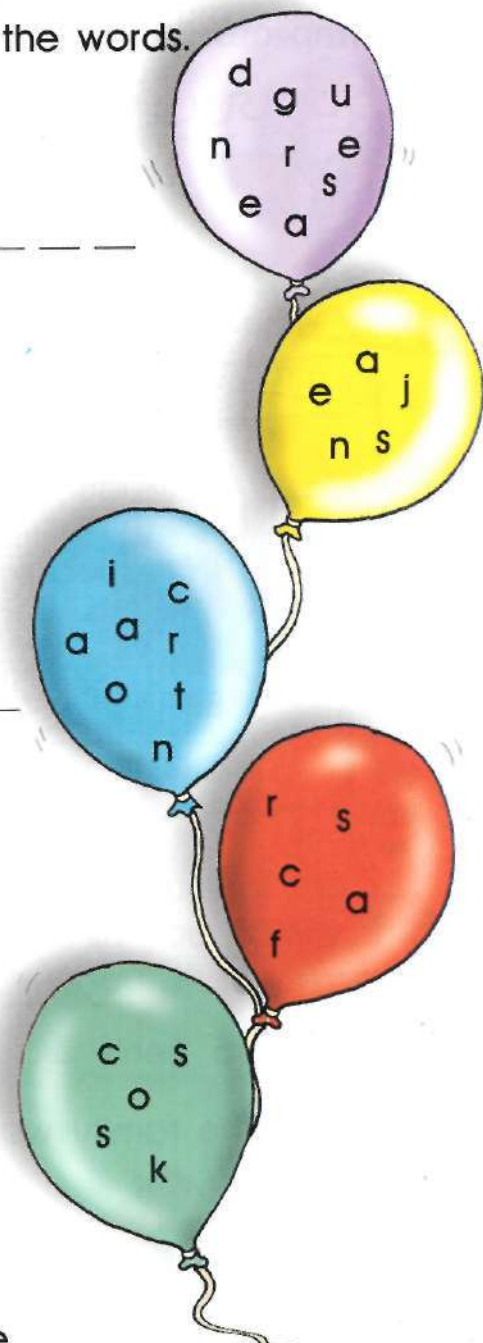

E What can you see in this wardrobe? Write.



1 a sweatshirt

2 _____

3 _____

4 _____

5 _____

6 _____

7 _____





PEOPLE: BEN AND VICKY'S FAMILY



A Who are these people?



1 Ben's grandma 2 Ben's _____



3 Ben's _____



4 Ben's _____



5 Ben's _____



B Look at the family tree in the picture dictionary and say who these people are.

- Nick Brown is Vicky and Ben's dad.
- Paul Brown is Vicky and Ben's _____.
- Becky Simpson is Vicky and Ben's _____.
- Andrew Simpson is Vicky and Ben's _____.
- Pat Brown is Vicky and Ben's _____.
- Jenny Brown is Vicky and Ben's _____.

C Circle the family words.



D Now, choose words from activity C and complete the table.

	
grandma	grandpa
_____	dad
sister	_____
_____	uncle
niece	_____

people: Ben and Vicky's family



Listen and complete the notes about Jamie's and Emma's families.

1



Name: Jamie

Sister's name: _____

Sister's age: _____

Brother's name: _____

Brother's age: _____

2



Name: Emma

How many aunts and uncles: _____

How many cousins: _____

Favourite cousin's name: _____

Cousin's age: _____

F Fill in your family tree.

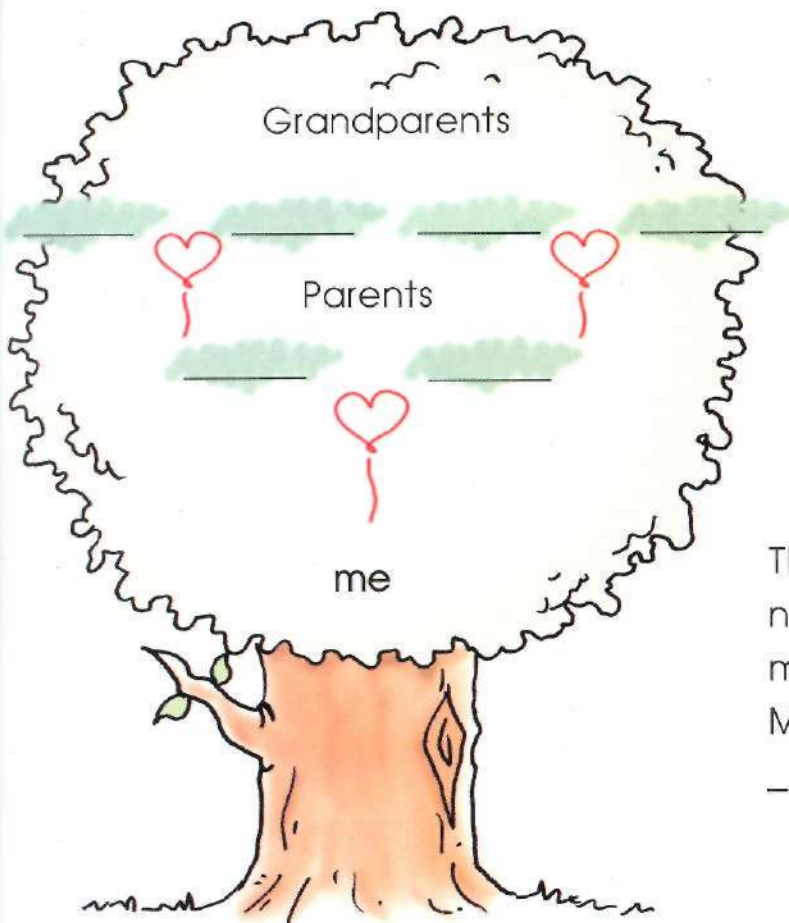

G Draw a picture of the people in your family and write about them.

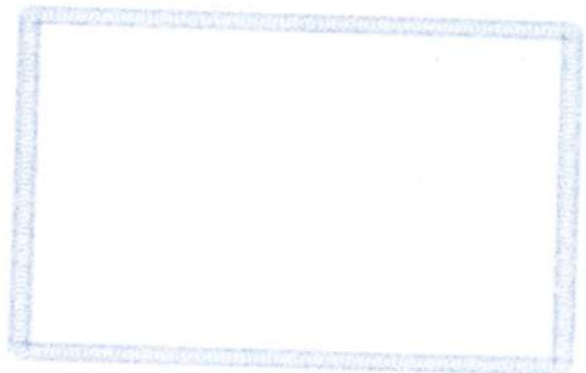

This is my _____, My father's name is _____ and my mother's name is _____, My name is _____ and I'm _____ years old.

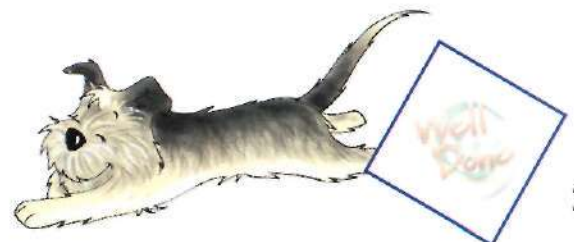

HOME: ON THE OUTSIDE

A What are these? Write the words. Then draw lines to put the jigsaw pieces in the correct place.

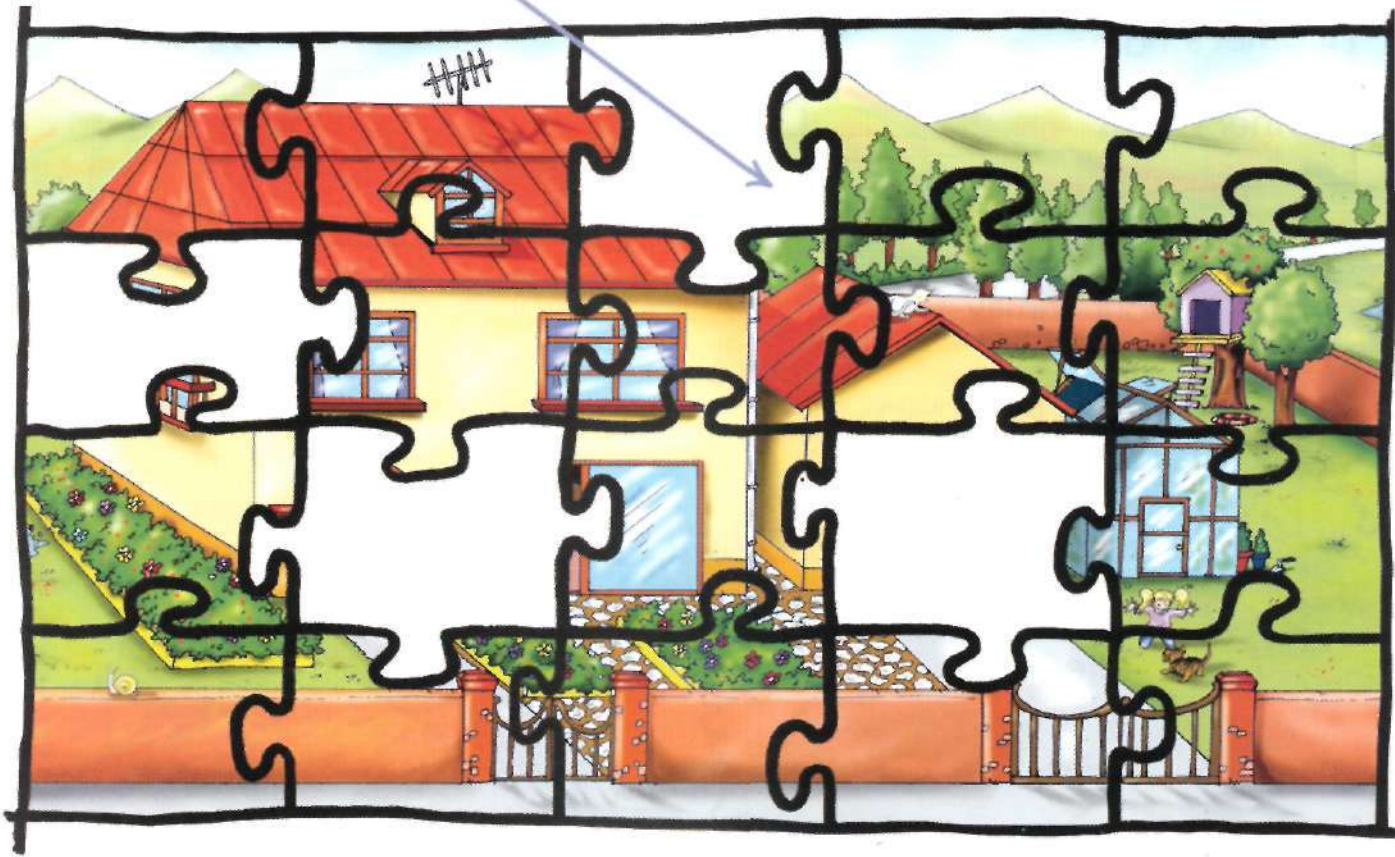
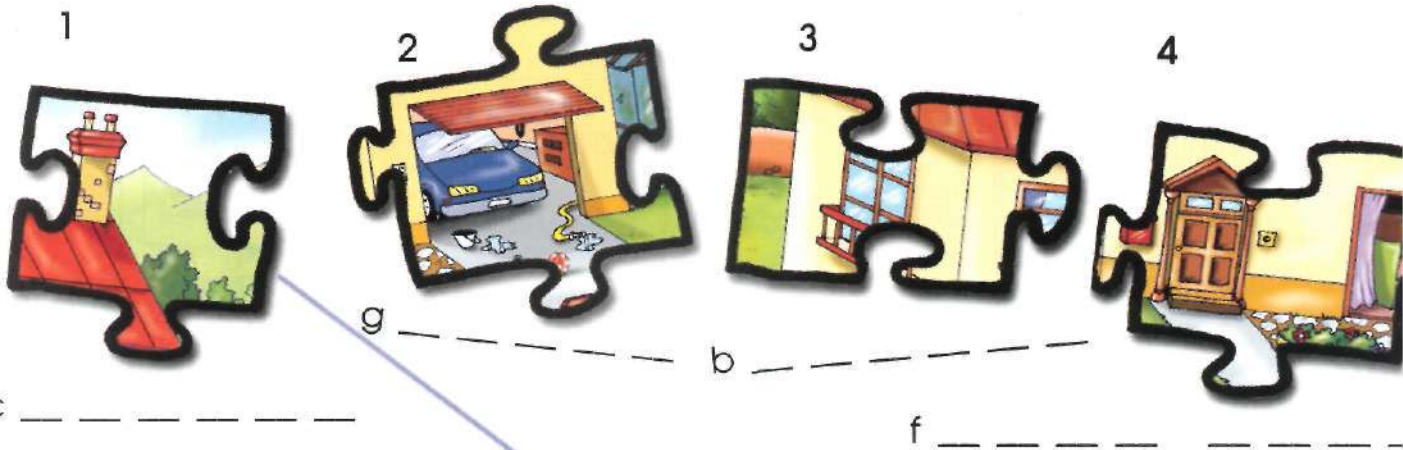

B How many words can you find in the streamer?



C Read and circle.



1 This is a detached house.

Yes/ No



4 This is a skyscraper.

Yes/No



2 This is a cottage.

Yes/No



5 This is a tent.

Yes/No

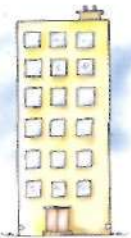

3 This is a block of flats.

Yes/No

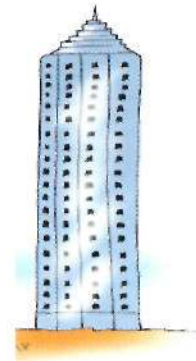

6 This is a lighthouse.

Yes/No

D Circle the odd word out.

- | | | | |
|----------|--------|-------------------|---------------|
| 1 roof | aerial | <u>greenhouse</u> | chimney |
| 2 window | patio | windowsill | French window |
| 3 fence | gate | garden | front door |

E Can you find 12 words in the wordsearch?

A L S R O E I F B S
 E G A T E R G E A T
 R C P V P O L N L E
 I A A T I K O C C P
 A S T E B L O E O V
 L T I N S E L B N I
 R L O T M Z C A Y L
 O E N N E S T A U L
 O A G A R D E N V A
 F C H I M N E Y F E

- | | | | |
|---|-------|----|-------|
| 1 | gate | 7 | _____ |
| 2 | _____ | 8 | _____ |
| 3 | _____ | 9 | _____ |
| 4 | _____ | 10 | _____ |
| 5 | _____ | 11 | _____ |
| 6 | _____ | 12 | _____ |



HOME: IN THE INSIDE I

A What are these? Write the words.

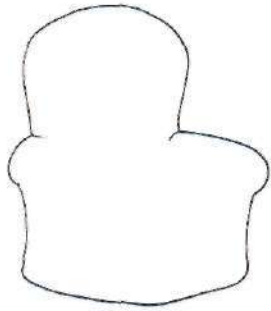

1 a r m c h a i r

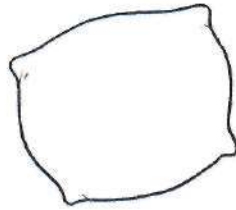

2 _____

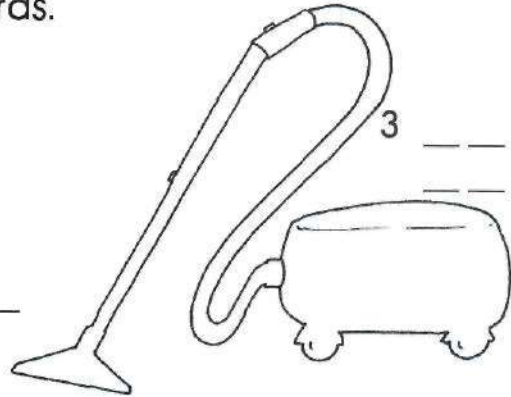

3 _____

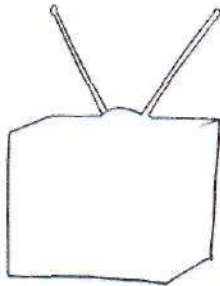

4 _____

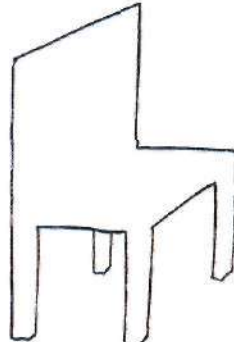

5 _____

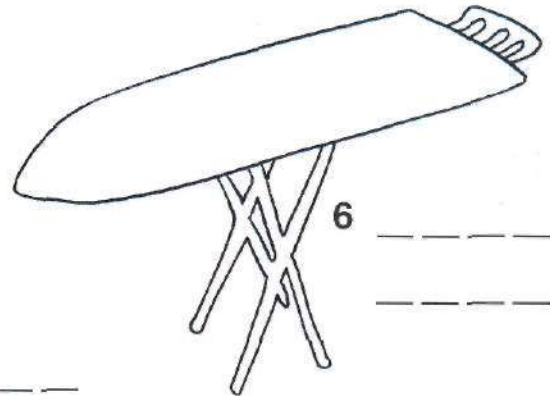

6 _____

B What are these? Write the words.

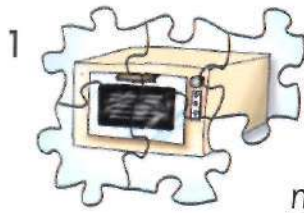

1 m i c r o w a v e



5 _____



2 _____



6 _____



3 _____



7 _____



4 _____



8 _____

C What a mess! Draw lines to put these things in the correct place.



oven



dishwasher



bin



fridge



cupboard

D Put these objects in the correct room.

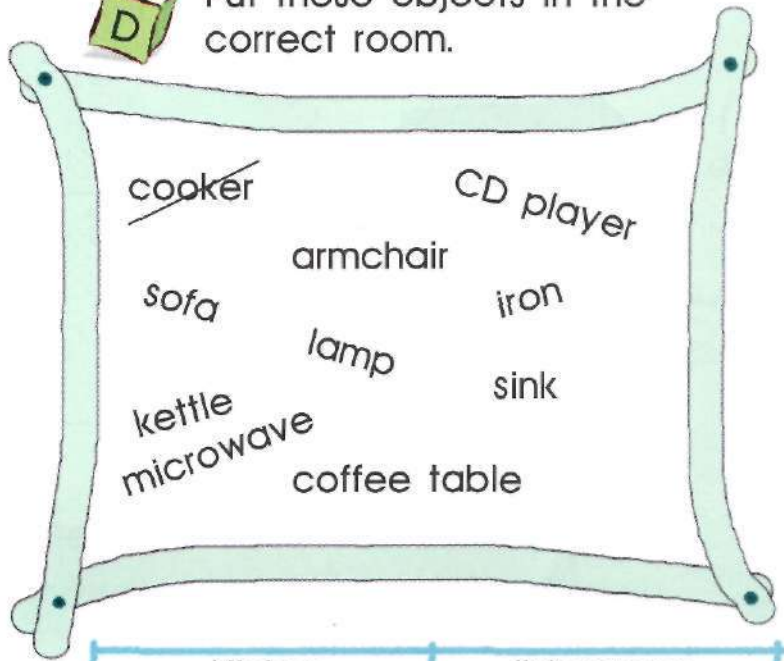

~~cooker~~

CD player

armchair

sofa

iron

lamp

sink

kettle
microwave

coffee table

kitchen	living room
cooker	

E Write the words. Then find them in the wordsearch.



1 telephone



7 _____



2 _____



6 _____



3 _____



4 _____



5 _____

F E T A B L E T
E F R I D G E E
L G R E O M P L
O V I S I N K E
B A D R D M A P
S S G I N G P H
C E E E A N E O
U C L O C K R N
R O I R O N L E

F What is there in your kitchen?

In my kitchen there is a(n) _____

_____ ,

and a(n) _____ ,

There is also a(n) _____

_____ , a(n) _____

_____ , a(n) _____

and a _____ .



HOME: IN THE INSIDE II

A Look at the pictures and letters and write the words.

1



2



3



4



5



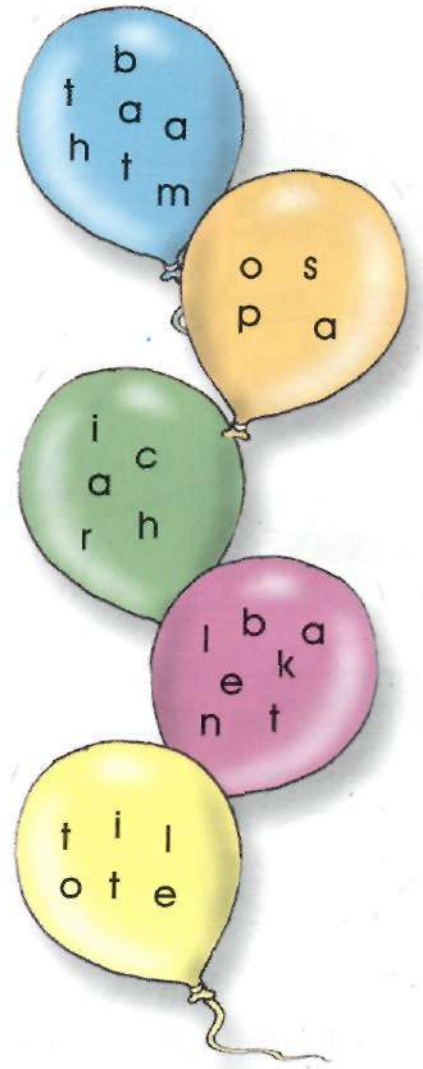

B What are these? Write the words.

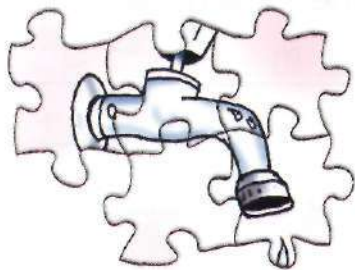

1 _____

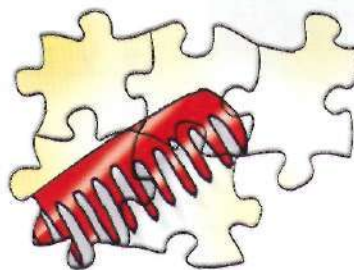

2 _____

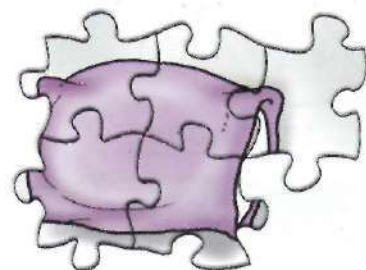

3 _____



4 _____



5 _____



6 _____



Join the dots. What can you see?

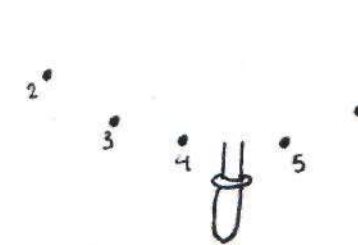

1 a _____

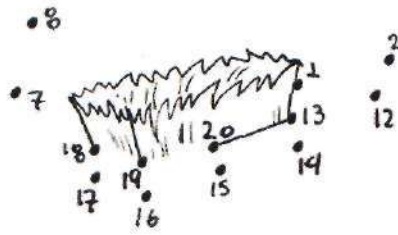

2 a _____

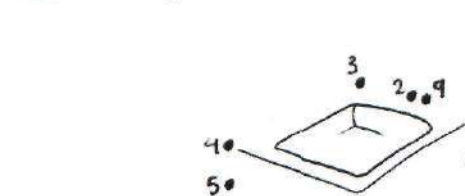
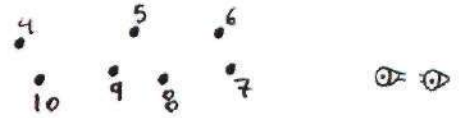

3 a _____



Put these objects in the correct room.

bed, sponge, pillow, sheets, bathmat, a bottle of shampoo, desk, toothbrush, duvet, towel

Bedroom	Bathroom
bed	



Play Bingo! Circle five objects on your bingo card. Then listen. If you hear any of your circled objects, cross them out. The first student to cross out all of his/her objects shouts "Bingo!" and is the winner.



Use stickers to make your bedroom.

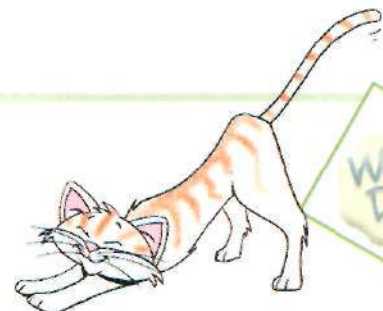

HOME: IN THE GARDEN

A Look at the pictures and write the words in the correct list.

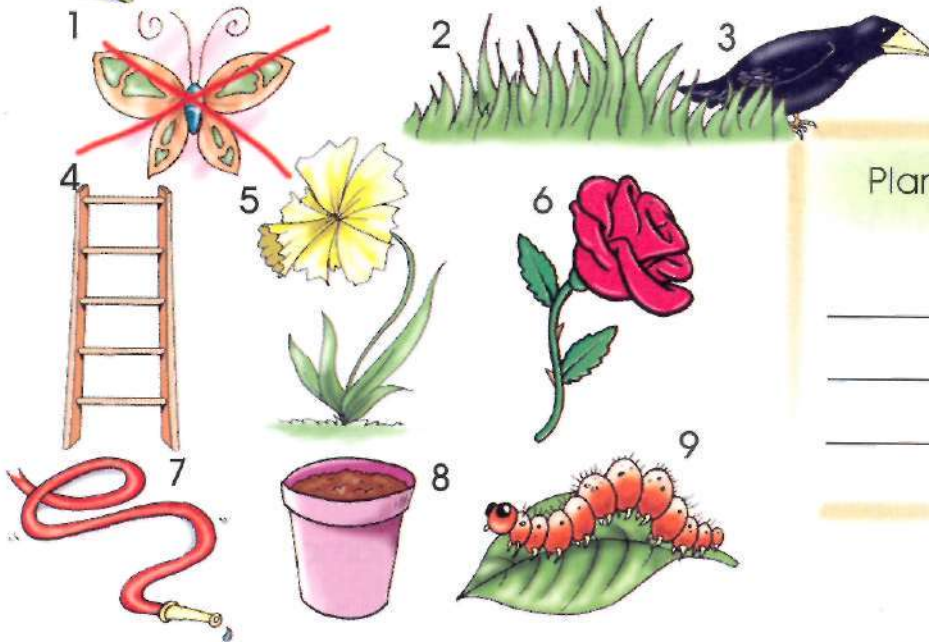

Plants	Animals	Garden things
_____	<u>butterfly</u>	_____
_____	_____	_____
_____	_____	_____

B Draw lines to join the words.

- | | |
|------------|-------|
| 1 garden | house |
| 2 plant | can |
| 3 paddling | pool |
| 4 tree | pot |
| 5 watering | table |

C Draw a picture of your favourite animal.



D Look at the numbers and colour the butterfly.

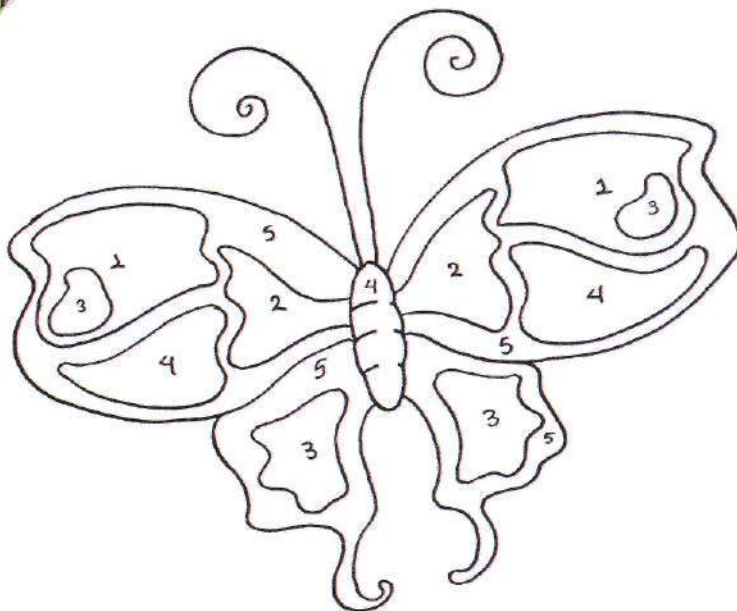

- 1 = black
- 2 = green
- 3 = red
- 4 = yellow
- 5 = purple

E Can you find these in the wordsearch?

F	R	O	G	E	T
P	T	H	M	B	A
A	R	C	P	A	T
T	E	N	O	T	M
H	E	A	W	T	O
F	H	F	O	X	T
W	O	R	M	O	T
O	U	B	L	X	N
G	S	N	A	I	L
A	E	G	U	L	S
E	R	L	E	A	F



F Look at the pictures and letters and write the words.



1 _____

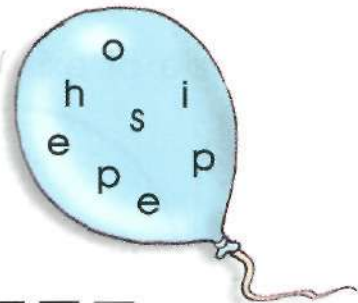

2 _____

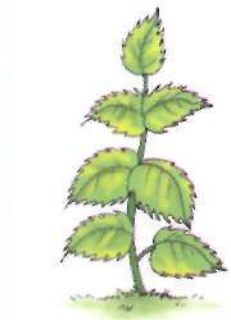
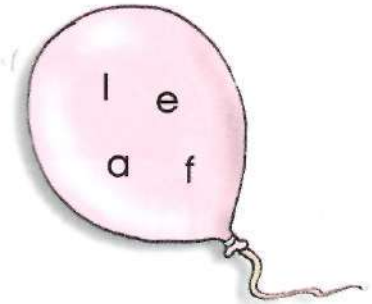

3 _____

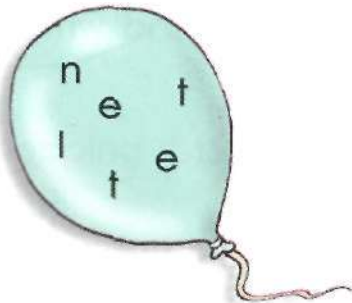

4 _____

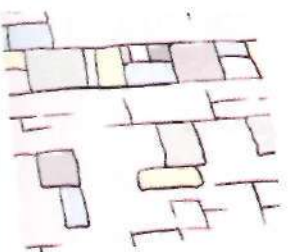
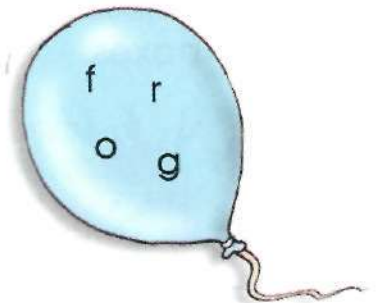

5 _____

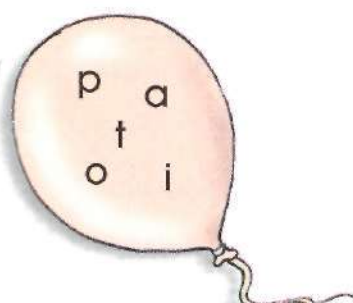

FOOD: AT THE SUPERMARKET

A Put the foods in the correct list.

	Fruit	Vegetables	Dairy Products
cheese broccoli cherries			cheese
potatoes butter carrot			
apples grapes milk			
margarine lemon onions			

B What's in the baskets? Look and write.



- 1 broccoli
- 2 _____
- 3 _____
- 4 _____



- 1 _____
- 2 _____
- 3 _____
- 4 _____



- 1 _____
- 2 _____
- 3 _____

C Whose baskets are these? Read the lists and write the names in the boxes.



Mark's basket
fish
eggs
peppers
strawberries



Emma's basket
cheese
aubergines
tomatoes
lettuce



Lucy's basket
carrots
pears
milk
bananas

D Complete the puzzle and find the hidden expression.

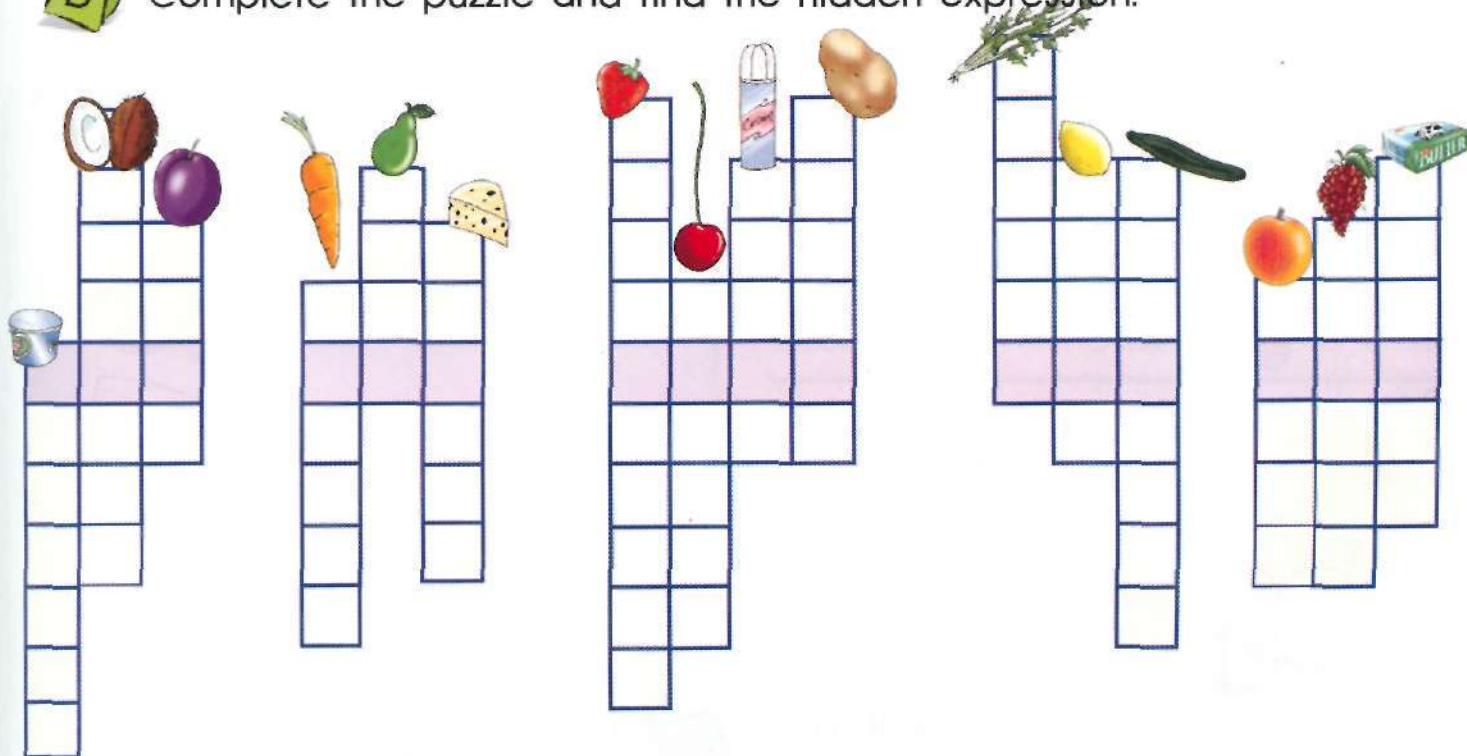

E Draw on the plates!

What do you like to eat?

What don't you like to eat?

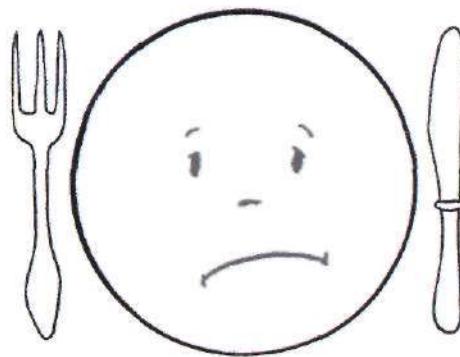
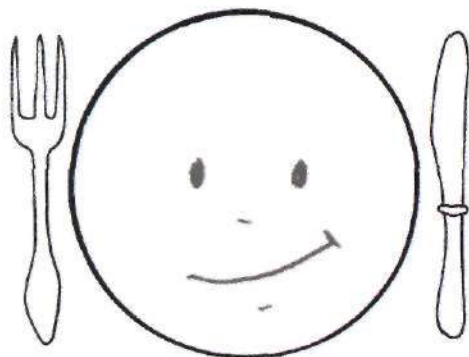

F Read the shopping lists. Then listen and write a number.

shopping list
butter
mushrooms
garlic
celery

shopping list
mushrooms
fish
lettuce
chocolate milk

shopping list
tangerines
chocolate milk
butter
cucumbers



FOOD: IN THE KITCHEN

A Where do you put these? Write the words and draw lines.

1



on a _____

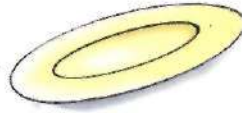

2



in a _____



3



in a _____



4



in a m u g



B What do you like to eat for breakfast? Draw the food on the plate.

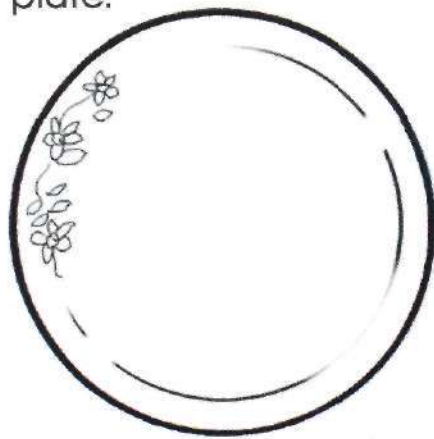

C Write the words. Then draw lines to match them.

1



c u p

a



2



b

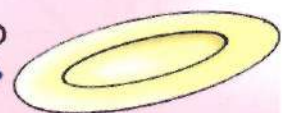

s a u c e

3



c



D What are these? Write the words.

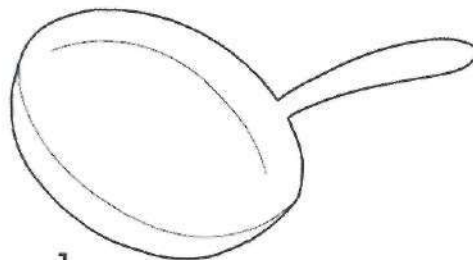

1 _____



2 _____

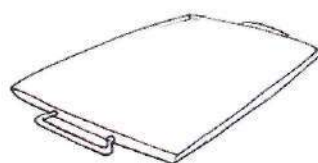

3 _____

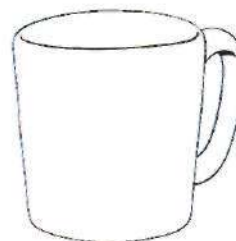

4 _____

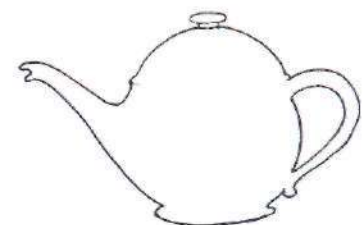

5 _____

E Draw lines to match the pictures with the words.

1		boil
2		stir
3		slice
4		fry
5		pour

F Put the words in the correct list.

plate, lunch, pepper, saucepan, knife, breakfast, napkin, sugar, olive oil, dinner, salt

OBJECTS	MEALS	THE BASICS
plate		

G Use stickers and set the table.

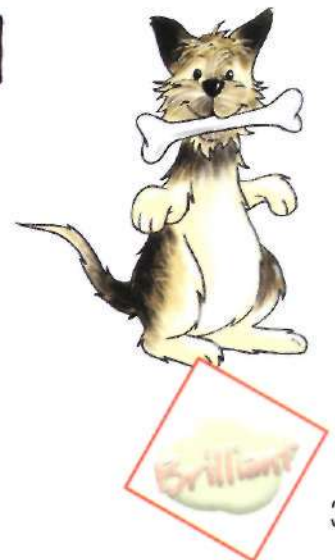
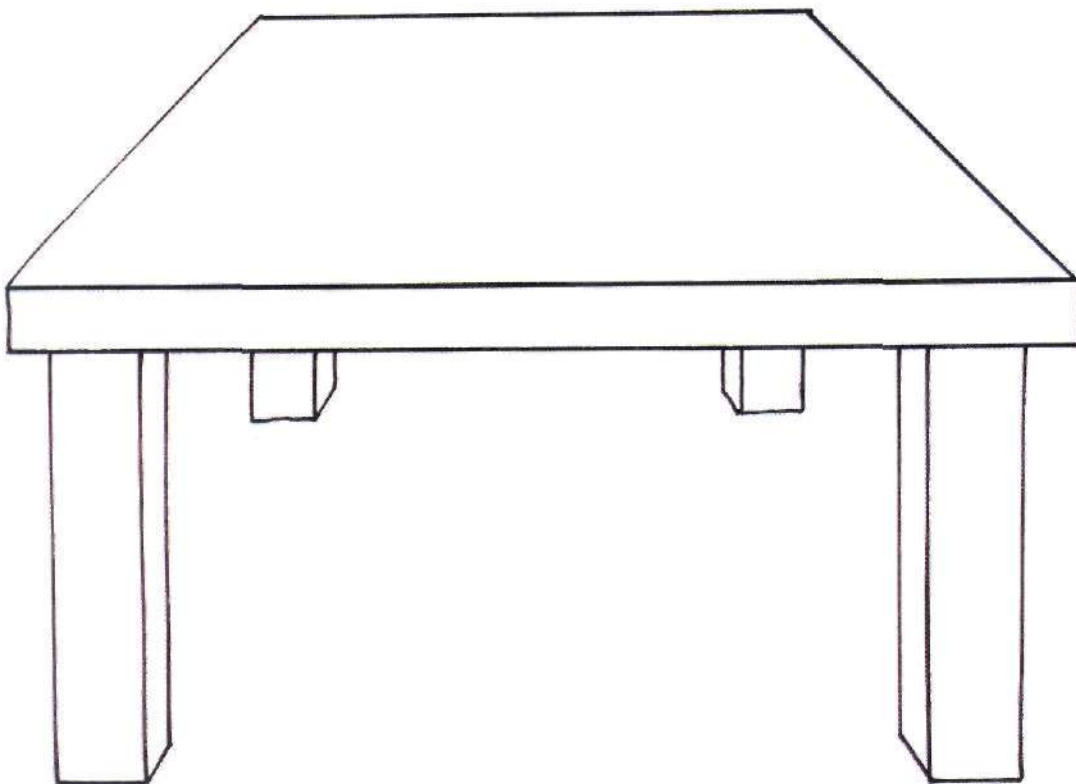

FOOD: A PARTY

A What are these? Write the words.

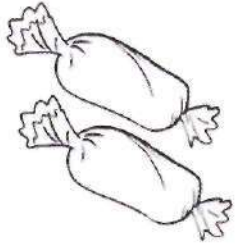

1 _____

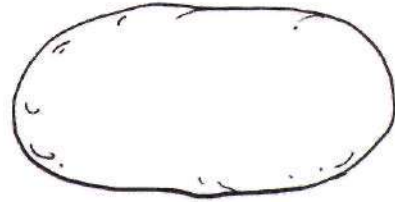

2 _____

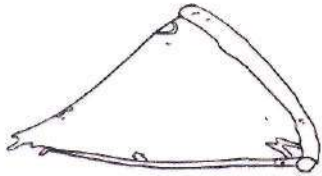

3 _____

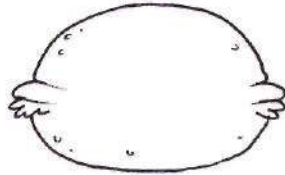

4 _____

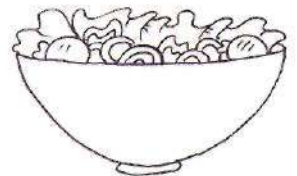

5 _____

6 _____

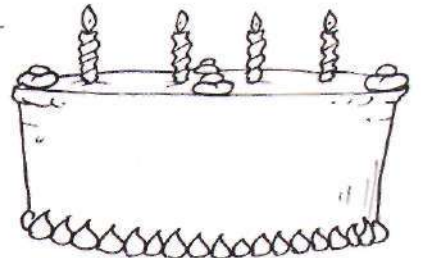

B What are these? Write the words.



1 _____



2 _____

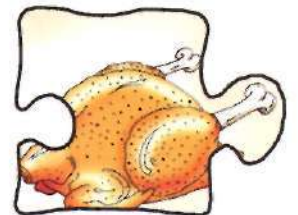

3 _____

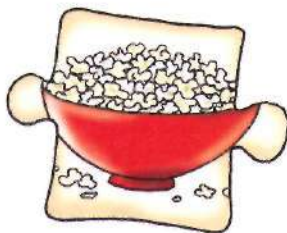

4 _____

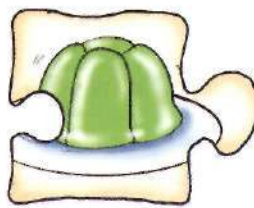

5 _____

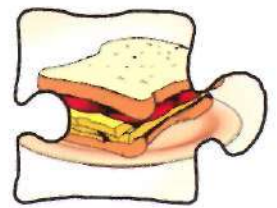

6 _____

C How many words can you find in the streamer?



D Complete the puzzle and find the hidden expression.

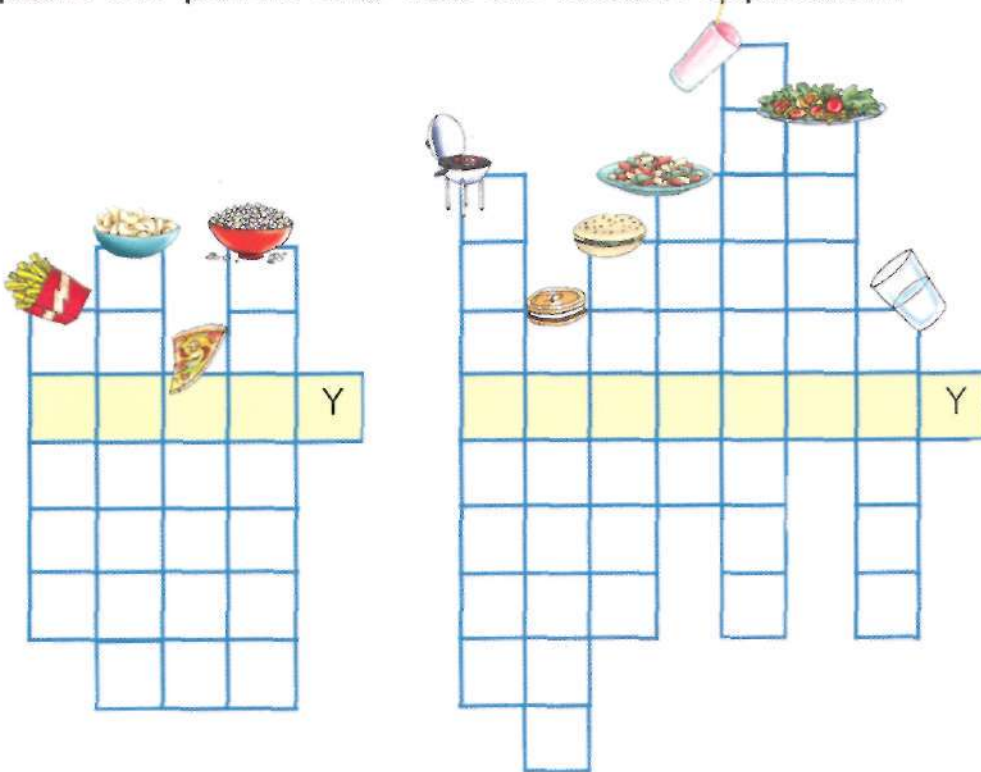

What are Paula and George eating? Listen and write their names under the correct plate.



F What do you eat at parties? What does your friend eat at parties? Make lists.

Me

My friend



TIME: WHAT'S THE TIME?



A Draw lines to match the times.

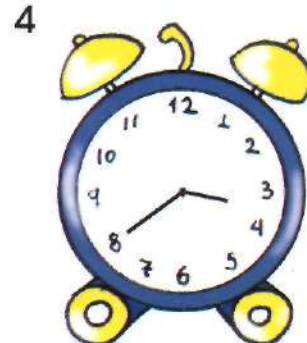

B Draw the times on the clocks.



It's half past six.

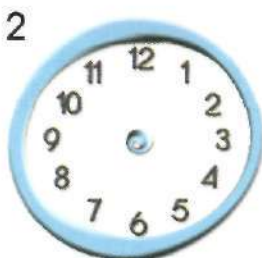

It's five to four.

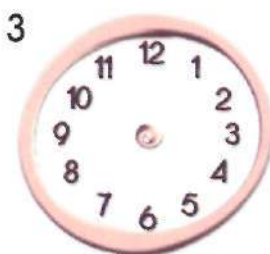

It's quarter past twelve.

It's quarter to two.

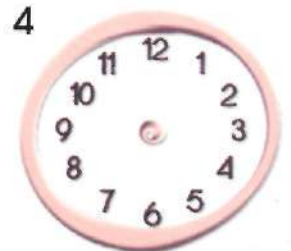

It's twenty past seven.

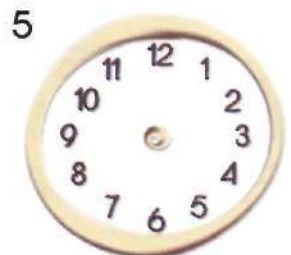

It's ten to eleven.

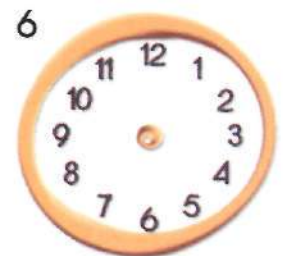



Look at the clocks and write.

go to school

have lunch

play basketball



1 I go to school at half 2 _____ 3 _____
past eight.

have dinner

go to bed

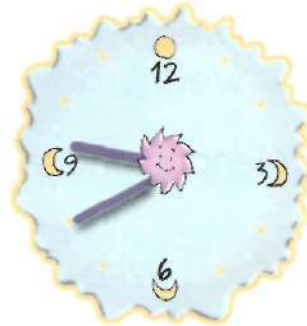
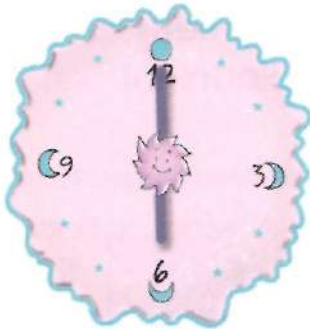

4 _____ 5 _____



What's the time? Listen to the clock and write.

- 1 It's _____ o'clock.
- 2 It's _____ o'clock.
- 3 It's _____ o'clock.
- 4 It's _____ o'clock.
- 5 It's _____ o'clock.

- 6 It's _____ o'clock.
- 7 It's _____ o'clock.
- 8 It's _____ o'clock.

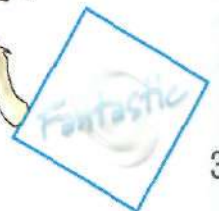



A Draw lines to match the short forms with the long forms.

B Circle the odd word out.

- | | | | |
|---------------|---------------|-----------|-----------|
| 1 morning | today | afternoon | evening |
| 2 weekday | week | night | weekend |
| 3 seventeenth | twenty-second | thirtieth | yesterday |
| 4 Monday | Wednesday | Fortnight | Friday |

C Look at the calendar and write.

MON	TUES	WED	THURS	FRI	SAT	SUN
8	9	10	11	12	13	14
15	16	17	18	19	20	21
22	23	24	25	26	27	28

Today is Monday 15th







What is the date
 next Monday? _____
 this Sunday? _____
 next Thursday? _____

What was the date
 last Monday? _____
 last Wednesday? _____

D Answer the questions. Then ask your friend.

- What do you do
- in the morning?
 - in the evening?
 - on weekdays?
 - at weekends?

E Look at the timetable and correct the sentences.

	JAMES	VICKY	BEN
MONDAY			
TUESDAY			
WEDNESDAY			
THURSDAY			
FRIDAY			
SATURDAY			
SUNDAY			

- 1 James goes to guitar class on Wednesday.
Wrong. He goes to guitar class on Monday.
- 2 Vicky goes dancing on Friday.
- 3 Ben goes swimming on Thursday.
- 4 James plays basketball on Wednesday.
- 5 Ben goes to the computer club on Tuesday.
- 6 Vicky goes to the cinema on Friday.
- 7 James has a barbecue on Sunday.

F How many words can you find in the streamer?

NIGHT EIGHTEENTH NIGHT DATE WEEKEND TWENTIETH FORTNIGHT





How many words can you find in the streamer?

AUTUMN AUGUST CENTURY SIGN BIRTHDAY DECADE YEAR JANUARY CAPRICORN



Write the months under the correct season.



Draw lines to match the pictures with the words.



- Leo
- Scorpio
- Capricorn
- Gemini
- Libra
- Pisces

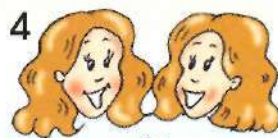



Ask your friends when their birthdays are. Then fill in the chart.

Name	Month	Date
_____	_____	_____
_____	_____	_____
_____	_____	_____
_____	_____	_____
_____	_____	_____
_____	_____	_____



Can you find 10 months in the wordsearch?

D	F	J	A	N	U	A	R	Y	N
E	S	A	A	L	M	L	J	M	O
C	J	E	B	B	K	M	U	A	V
E	U	O	K	R	Y	O	N	R	E
M	L	V	P	L	A	S	E	C	M
B	Y	T	O	S	O	O	I	H	B
E	K	V	T	B	T	M	A	Y	E
R	A	U	G	U	S	T	B	O	R
O	C	T	O	B	E	R	Q	F	B
F	E	B	R	U	A	R	Y	R	E



Fill in the missing months.

January, February, _____,
 _____, May, _____,
 July, _____, _____,
 October, _____, _____.



Maths!

1 1 year = 365 days

6 2 millennia = _____ years

2 2 years = _____ days

7 3 leap years = _____ days

3 1 decade = _____ years

8 10 decades = _____ century

4 4 decades = _____ years

5 3 centuries = _____ years



SCHOOL: MY SCHOOL

A Fill in your school timetable with the subjects you do at school.

	Monday	Tuesday	Wednesday	Thursday	Friday
8-9					
9-10					
10-11					
11-12					
12-1					
1-2					
2-3					

B Which subjects are these? Complete the puzzle.

$\frac{5}{8} + 7^2 \cdot (x+y) = \sqrt{2} - 8 > 2 =$
 Bonjour Buenas dias
 1 _____
 2 _____
 3 _____
 4 _____

C What shapes are these? Write the words.

1 _____
 2 _____
 3 _____
 4 _____

D How many words can you find in the streamer?

MUSIC SECONDARY SCHOOL LANGUAGES CHANGING ROOMS LIBRARY WRITE



Draw lines to match the pictures with the verbs.



ask and answer

play

listen

write

read

sing

look

speak

think



Look at the pictures and complete Ben's letter.

Dear Mohammed,

Hi from England! You wanted to

know about my  (1) _____.

Well, I am not in  (2) _____

school anymore. I am in  (3) _____ school, so I know how

to read and  (4) _____.

We do a lot of subjects at school

but my favourite ones are

(5) _____,  (6) _____

and  (7) _____. My

 (8) _____ is on the 2nd

floor. School is lots of fun and I have

many friends. What are schools like in

your country?

Write soon,

Ben



Circle the odd word out.

- | | | | |
|------------------|----------------|------------|------------------|
| 1 English | Gym | Maths | Geography |
| 2 Classroom | Library | Staff room | Square |
| 3 Art | Circle | Triangle | Rectangle |
| 4 Listen | Playground | Read | Write |
| 5 Nursery School | Primary School | History | Secondary School |



SCHOOL: BEN'S CLASSROOM

A Look at the pictures and letters and write the words.

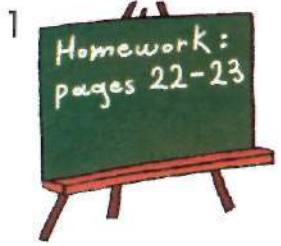



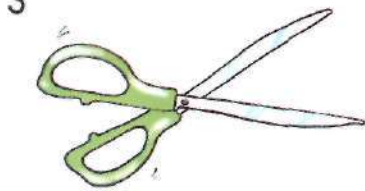



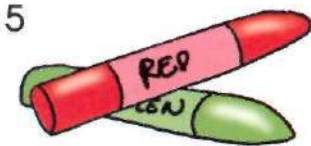



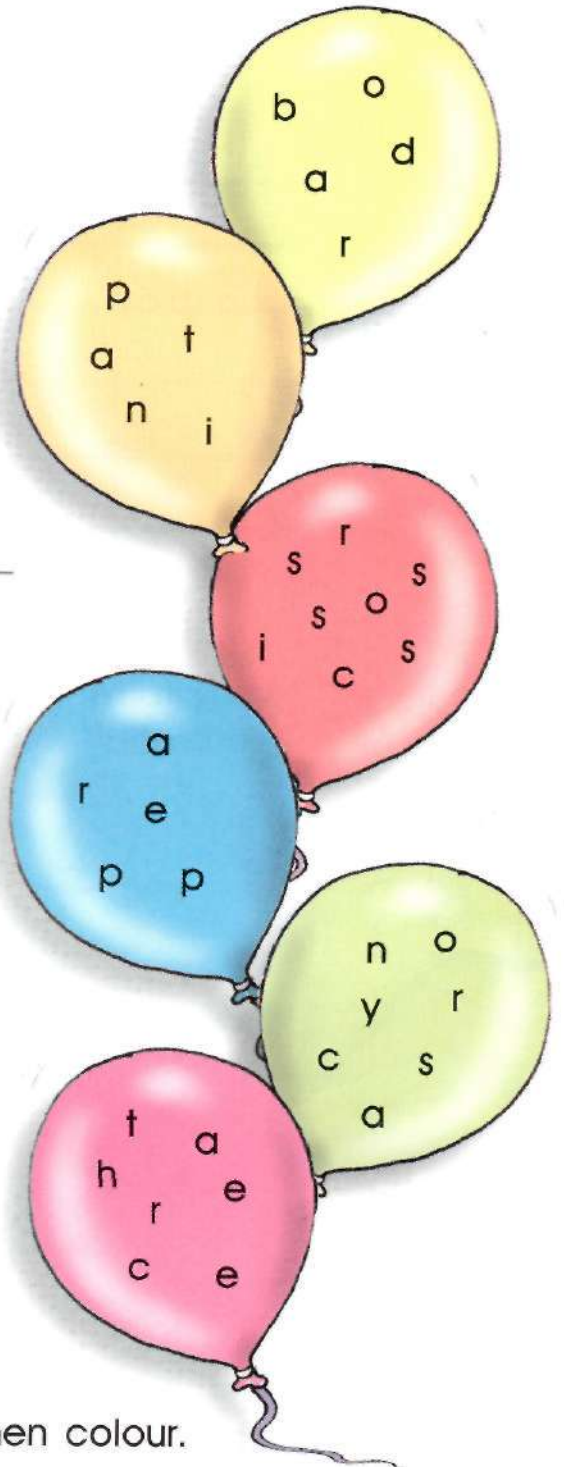

B What are these? Write the words, then colour.

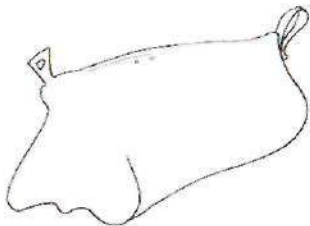

1 -----



2 -----

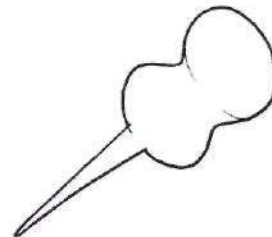

3 -----

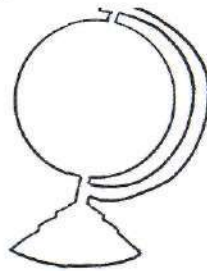

4 -----

C Draw lines to match the words with the pictures.

1

2

3

4

5

6

paintbrush
notebook
coloured pencils
bell
computer
pencil sharpener

D Circle the odd word out.

- | | | | |
|------------|----------|-------|-------------|
| 1 bookcase | desk | shelf | paperclip |
| 2 pencil | rubber | pen | crayon |
| 3 glue | scissors | shelf | sticky tape |

E What have these children got in their schoolbags? Listen and write a number.

A

B

C

Fantastic



SCHOOL: IN THE COMPUTER ROOM



Draw lines to join the words. Then write them.

1 disk	ROM
2 CD-	disk
3 floppy	drive
4 power	pad
5 mouse	mail
6 e-	switch



Look at the pictures and letters and write the words.

1



2



3

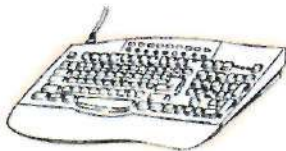

4



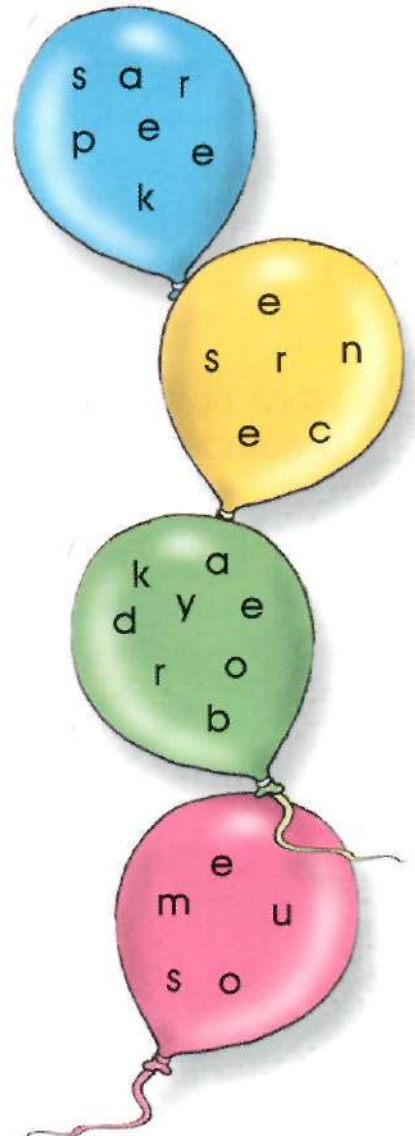

C Use the words and label the picture.

keyboard, plug, modem, mouse, wire, disk drive, speaker, tower, power switch, printout

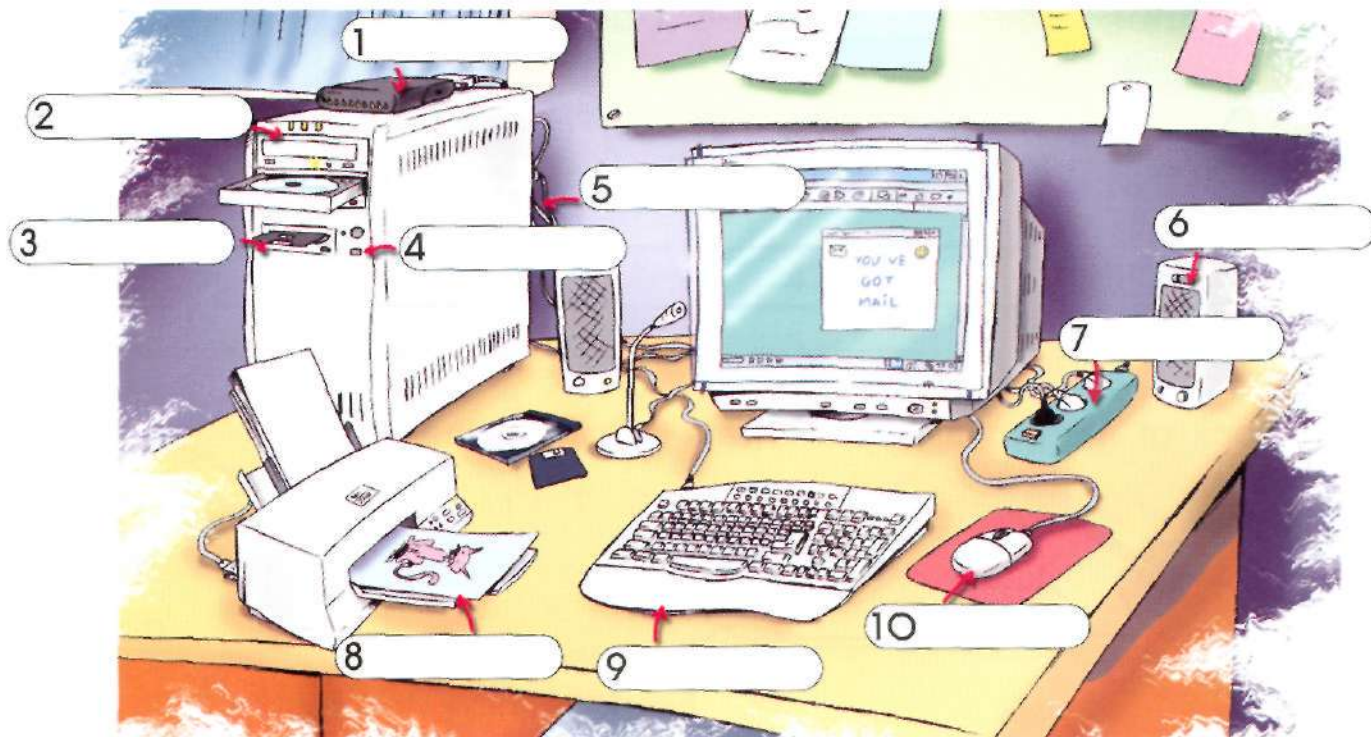

D Look at the pictures and complete the puzzle.

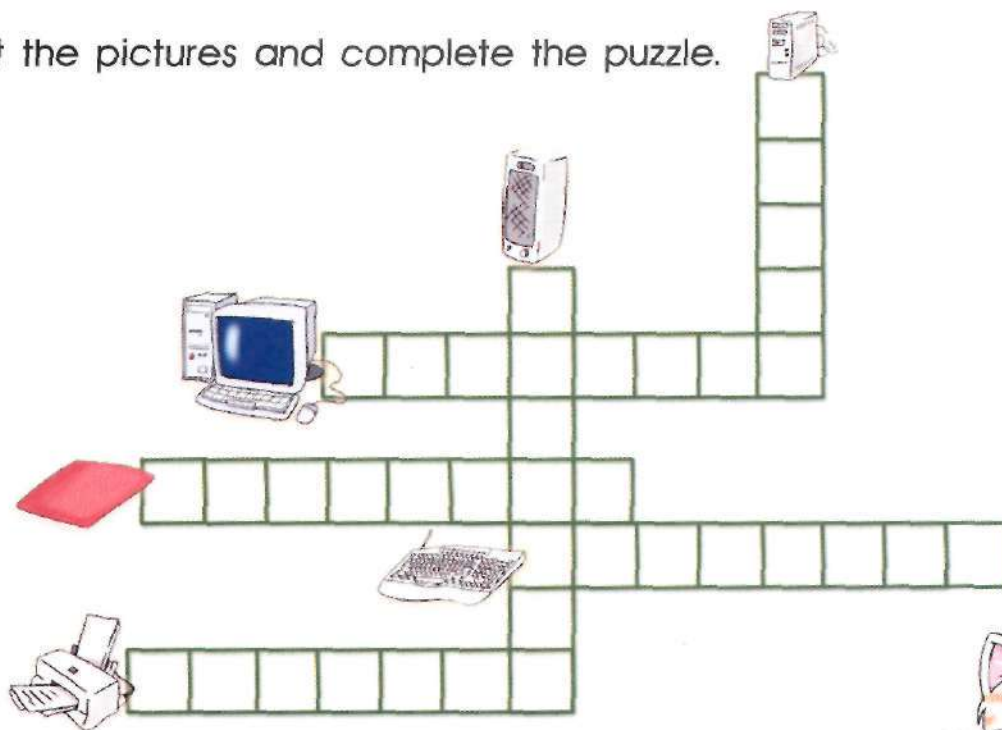





E How many words can you find in the streamer?

WIRE FLOPPY DISK CD RECORDER E-MAIL PLUG SCREEN







SCHOOL: THE MUSIC ROOM

A Put the words in the correct list.

trombone	clarinet	cello	triangle
trumpet	flute	double bass	cymbals
Brass	Percussion	Strings	Wind
			
trombone			

B Look at the pictures and letters and write the words.

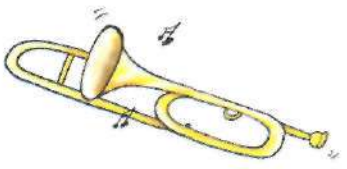
-  _____
-  _____
-  _____
-  _____
-  _____
-  _____

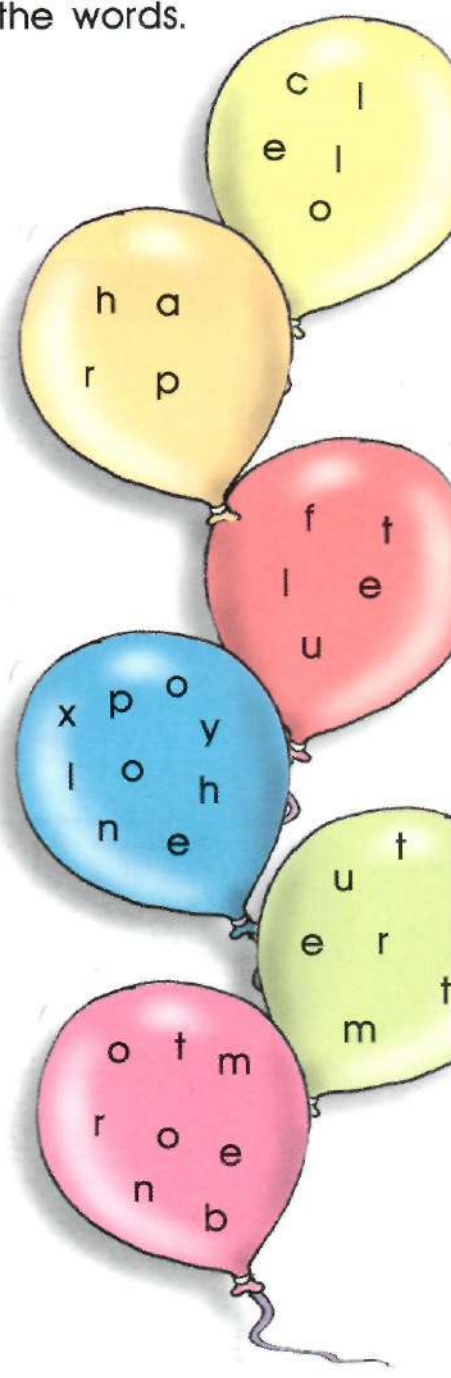



Can you find 12 musical words in the wordsearch?

S Y N T H E S I Z E R T
 R M D O B A N D B C P R
 E C H O I R E P R H L I
 C M U S I C S T A N D A
 D O U B L E B A S S Y N
 R L C G I H L A S R E G
 D K N C Y M B A L S R L
 E M J X I W S R B S P E
 H A R M O N I C A N L H
 C L A R I N E T A O A A
 R E C O R D E R Z T A R
 T R O M B O N E F T D P

- 1 synthesizer 7 _____
- 2 _____ 8 _____
- 3 _____ 9 _____
- 4 _____ 10 _____
- 5 _____ 11 _____
- 6 _____ 12 _____



Do you play a musical instrument? Which instrument would you like to play? Draw a picture.

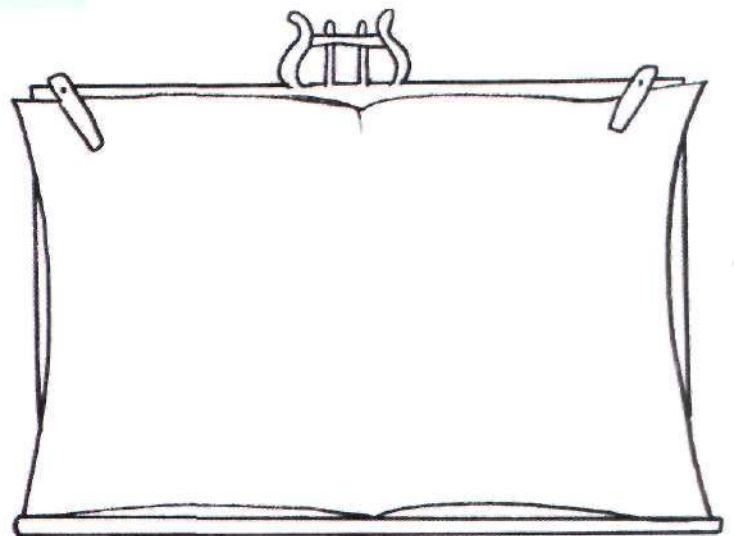

Listen to these instruments and write a number.



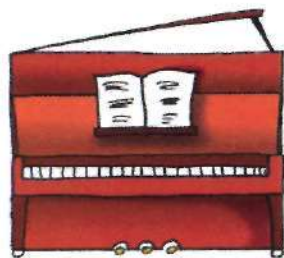









SCHOOL: JOBS

A Read and circle.



Bob is a builder.

Yes/No

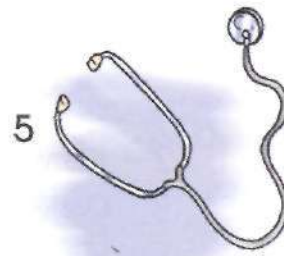

Mary is a doctor.

Yes/No



Tim is a journalist.

Yes/No



Carl is an actor.

Yes/No

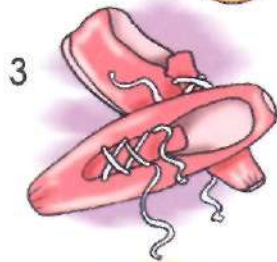

Sheila is a nurse.

Yes/No

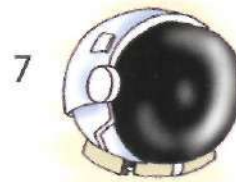

Betty is an astronaut.

Yes/No



Lee is a photographer.

Yes/No

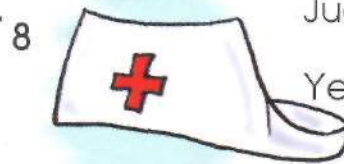

Judy is a nurse.

Yes/No

B Can you find 12 jobs in the wordsearch?

F	C	D	E	S	O	L	D	I	E	R
I	P	I	L	O	T	E	A	K	L	Q
R	X	A	E	B	S	A	I	L	O	R
E	W	D	C	I	O	A	Q	P	S	V
F	U	O	T	A	E	R	S	V	E	T
I	T	C	R	C	S	C	P	M	U	V
G	K	T	I	T	J	H	A	H	X	F
H	G	O	C	O	S	I	N	G	E	R
T	J	R	I	R	B	T	N	O	W	J
E	Y	D	A	N	C	E	R	L	U	C
R	I	Z	N	C	E	C	V	D	K	F
A	S	E	C	R	E	T	A	R	Y	B

- | | | |
|----|-------|---------|
| 1 | _____ | soldier |
| 2 | _____ | |
| 3 | _____ | |
| 4 | _____ | |
| 5 | _____ | |
| 6 | _____ | |
| 7 | _____ | |
| 8 | _____ | |
| 9 | _____ | |
| 10 | _____ | |
| 11 | _____ | |
| 12 | _____ | |



Where do these people work? Draw lines to match the words with the pictures.

1



2



3

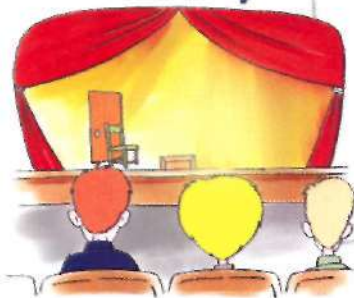

actor

journalist

postal worker

teacher

police officer

doctor

4



5



6



What do these children want to be? Listen and draw lines.

1



Catherine

2



Brett

3



Zoe



What do you want to be? Draw and write.



ACTIVITIES: INDOOR HOBBIES

A Look at the pictures and write the words in the correct list.

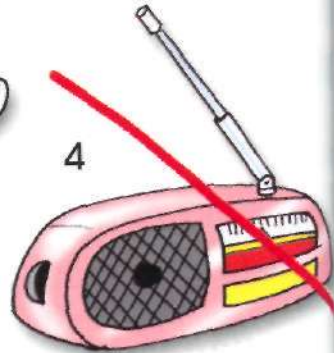
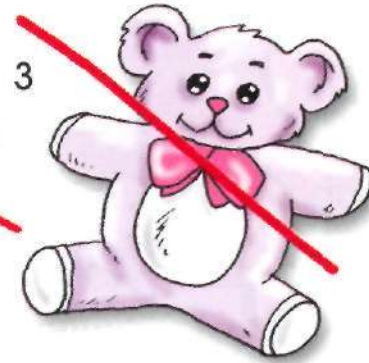

A. playing
 the piano

B. listening
 to the radio

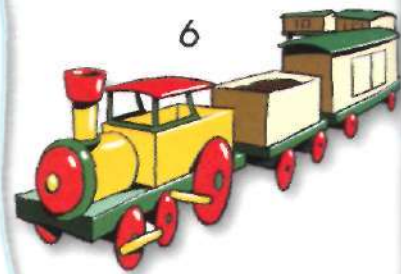

C. collecting
 coins

D. toys
 teddy bear

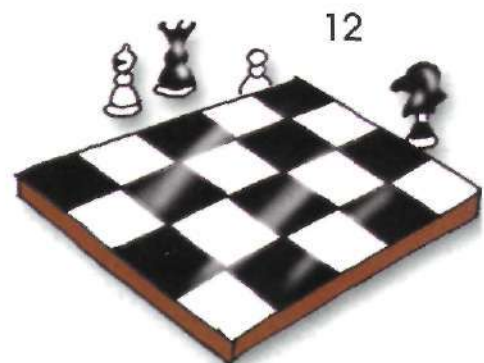
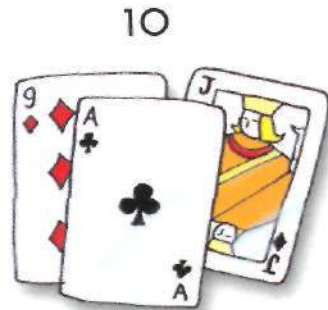
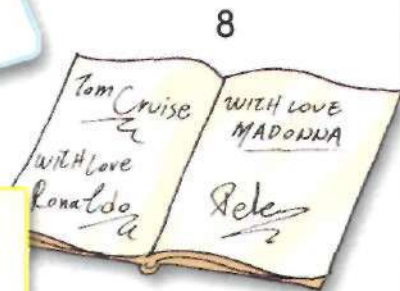



B Look at the pictures and complete Vicky's letter.

Dear Francoise,

Hello, how are you? Thank you for your letter about your hobbies.

I like to do a lot of things in my free time, too. I often play with my cousin,

Becky. Becky draws 1)  _____ and I 2)  _____ them.

We both like playing with our 3)  _____, our 4)  _____

and our 5)  _____. We also like watching 6)  _____.

7)  _____ to music, and writing 8)  _____

and 9)  _____ to our friends. Ben usually watches

10)  _____ or plays on the 11)  _____. How boring!

That's all for now.

Write soon,

Love,

Vicky

C Answer Vicky's letter!

Dear Vicky,

Hello, how are you? Thank you for your letter about your hobbies.

I like _____

Write soon.

Love,



What are these children's hobbies? Listen and draw lines.



Andrew
Gemma
Mary



ACTIVITIES: AT THE PARK

A Draw lines to match the activities with the pictures.

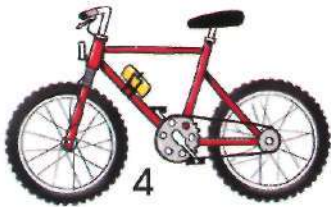
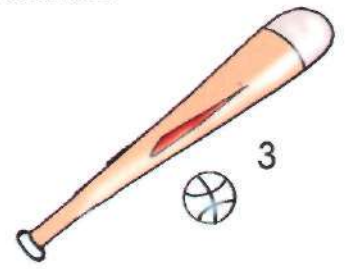
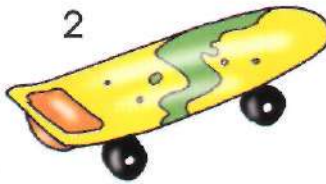

- tennis
- football
- cycling
- baseball
- skipping
- rollerblading
- skateboarding

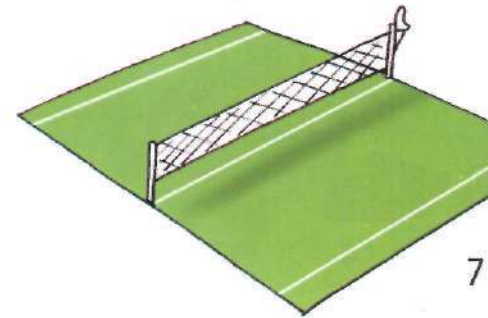
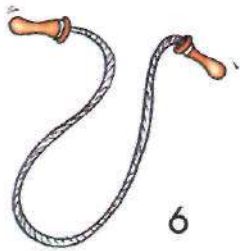

B What are these? Write the words.

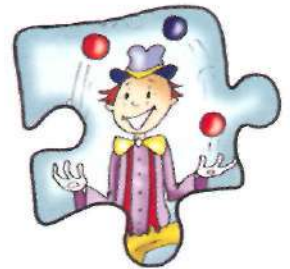

1 _____

2 _____

3 _____

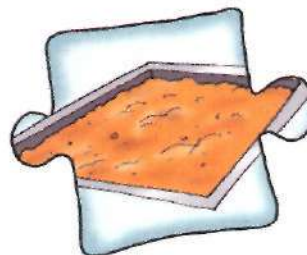

4 _____

5 _____

6 _____



Can you find these in the wordsearch?

I C E C R E A M V A N
 J P T S H W H A I R H
 U P G N I L G G R J O
 G I B S G O A L A S P
 G O E O W X O B C E S
 L N N V B I K E Q E C
 E K C S L R N S U S O
 R M H P A T H G E A T
 S A N D P I T O T W C
 S K A T E B O A R D H
 R O U N D A B O U T E
 B U K Q L R B A R H B



Put the words in the correct list.

~~tennis~~, skipping, a picnic, football, hopscotch, baseball, an ice cream, skateboarding, a sandwich, cycling, rollerblading

PLAY	GO	HAVE
tennis		



Which three activities can you hear? Listen and write a number.



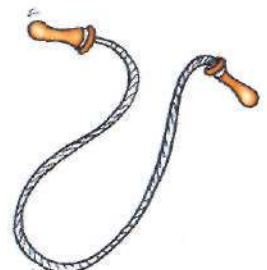







ACTIVITIES: AT THE SPORTS CENTRE

A Draw lines to match the sports with the pictures.

1

2

3

4

5

6

badminton

table tennis

archery

basketball

ice-skating

fencing

B Label the picture with the words.

swimming pool, goggles, armbands, ladder, diving board

1

2

3

4

5



Look at the pictures and letters and write the words.

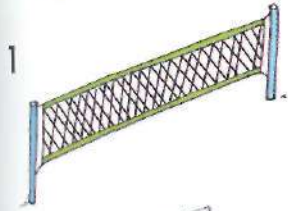







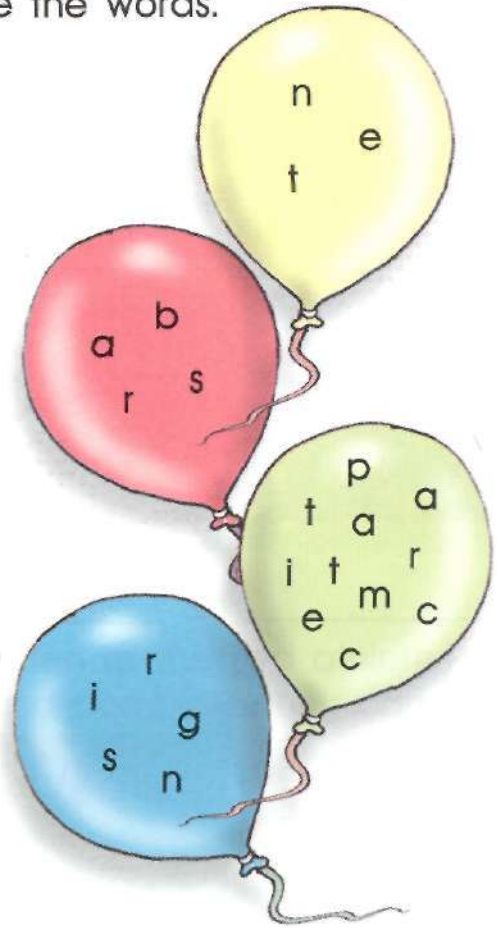

Circle the odd word out.

- | | | | |
|--------------|------------|-----------|--------------|
| 1 basketball | badminton | rings | table tennis |
| 2 foil | gymnastics | iceskates | armbands |
| 3 iceskating | swimming | diving | goggles |
| 4 fencing | racquet | net | shuttlecock |



Which sports are these children going to do? Listen and draw lines.

Matthew

Rachel

Katy



3 ACTIVITIES: AT THE STADIUM

A Label the pictures with the words.

podium, weightlifting, spectators, relay, long jump, seats, runner, discus



1 _____

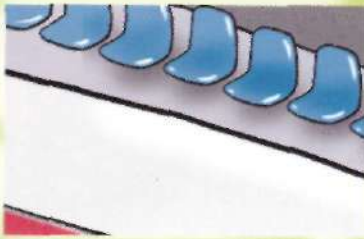

2 _____



3 _____



4 _____



5 _____



6 _____



7 _____



8 _____

B Read and choose the correct answer.

The Olympic Games take place every 1) _____ years. They take place in 2) _____ country every time. Millions of 3) _____ around the world watch the games. There are a total of 4) _____ sports and 296 events. The best athletes get gold, silver or bronze 5) _____.

- | | |
|----------------|---------------|
| 1 A four | B two |
| 2 A the same | B a different |
| 3 A spectators | B runners |
| 4 A 28 | B 128 |
| 5 A bracelets | B medals |

C Can you find 9 words in the wordsearch?

H P O D I U M S C E M
 U A S P E C T A T O R
 R E R E L A Y L I K I
 D R O I E L A N E P E
 L N S E O R C O I I A
 E N R T I C K E T C I
 S E A T A G L T R I E
 A E T R A C K T T T E
 N N N A O M E D A L I

- | | |
|----------|---|
| 1 podium | 6 |
| 2 | 7 |
| 3 | 8 |
| 4 | 9 |
| 5 | |

D Draw lines to join the words.

1 finishing	jump
2 pole	medal
3 high	line
4 gold	vault

(A blue line is drawn connecting 'finishing' to 'line')

E Listen to the two athletes and complete their cards.

1

Name: Carole Tinley

Age: _____

Sport: _____

Place: _____

Medal: _____



Olympic Games 2004

2

Name: Darren Stevens

Age: _____

Sport: _____

Place: _____

Medal: _____



Olympic Games 2004

F How many words can you find in the streamer?

TRACK HURDLE TICKET STARTING LINE JAVELIN DISCUS BRONZE MEDAL



ACTIVITIES: OUTDOOR ACTIVITIES

A Where do you do these activities? Put the words in the correct list.

~~rowing~~
windsurfing
snowboarding
skiing
sailing
hang-gliding

mountain biking
paragliding
canoeing
climbing
scuba diving

in the mountain	in the water	in the air
	rowing	

B Draw lines to match the words with the pictures.

C Ask your friends. What activities do they like to do? What equipment do they use?

Name	Activity	Equipment
_____	_____	_____
_____	_____	_____
_____	_____	_____
_____	_____	_____
_____	_____	_____

D True or False? Read and put a tick (✓) or a cross (X).

You need ...

- 1 a rucksack to go hiking. _____
- 2 an oxygen cylinder to go horse riding. _____
- 3 a rope to go snowboarding. _____
- 4 a boat to go sailing. _____
- 5 reins to go rowing. _____
- 6 a wetsuit to go scuba diving. _____

E Read and draw the equipment.



1 a sleeping bag



2 a map



3 a windsurfer



4 oars



5 a canoe



6 flippers

F Look at the pictures and complete the puzzle.

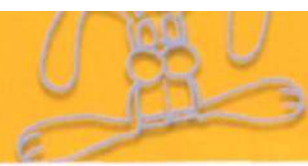

A

Label the pictures with the words.

tail, feathers, fur, whiskers, beak, paws, claw, wing

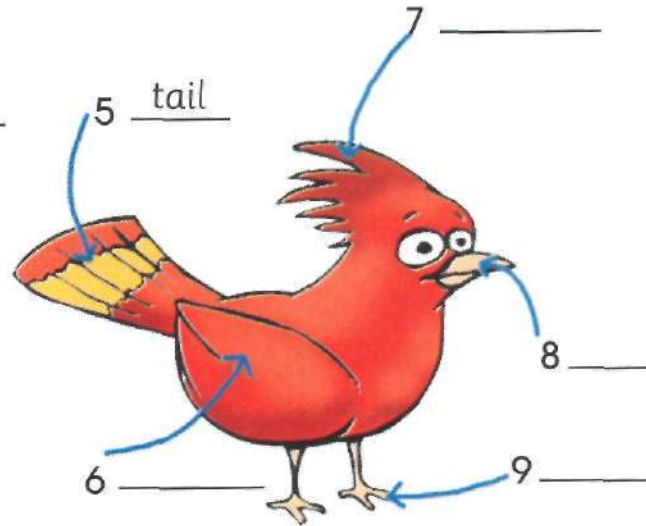
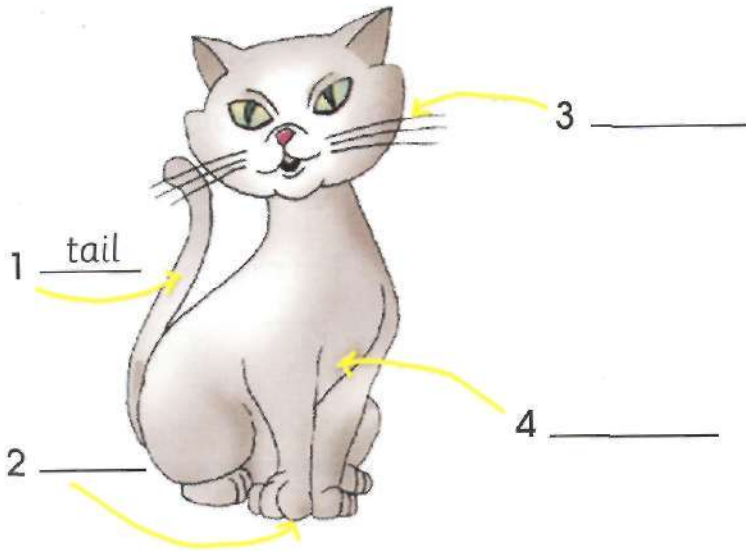

B

What are these? Write the words then say which animals live in them.

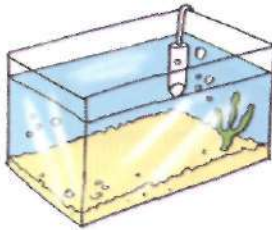

1 _____

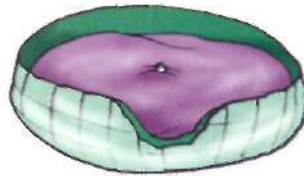

2 _____

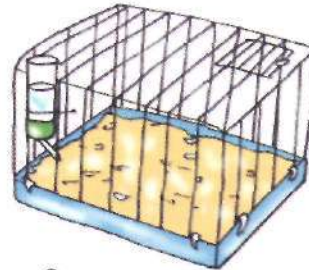

3 _____



4 _____

C

Join the dots. Which animals are they?

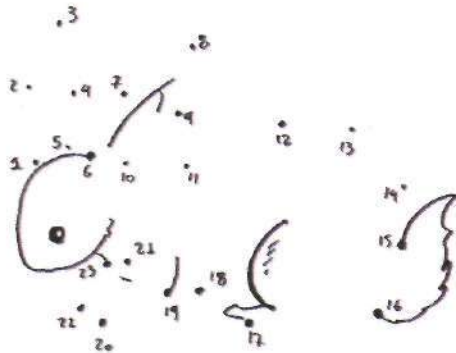

1 It's a _____





2 It's a _____



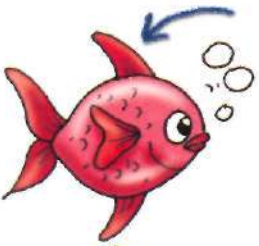

3 It's a _____

D Look at the pictures and letters and write the words.

1  _____

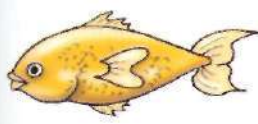
2  _____

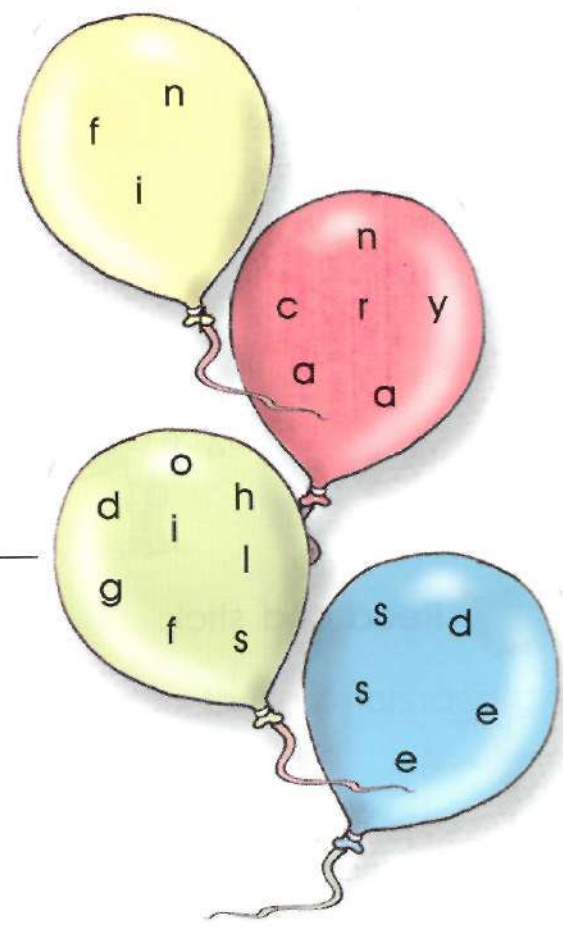

3  _____

4  _____





E Look at the pictures and write the words.

This is my pet  1) _____

His name's Mac. He loves to eat  dried 2) _____. He  sleeps in a big 3) _____

_____ Mac loves to sleep all day long.

This is my pet  4) _____

His name's Bruno. He likes to eat  5) _____. He sleeps in his  6) _____ in the garden. Bruno loves going for long walks.



ANIMALS: ON THE FARM

A Draw lines to match the words with the pictures.

1 2 3 4 5 6 7

cow
chicken
duck
horse
swan
goat
sheep

B Read and stick.



a scarecrow



a sheepdog



a duckling



a buffalo

C Look at the pictures and letters and write the words.



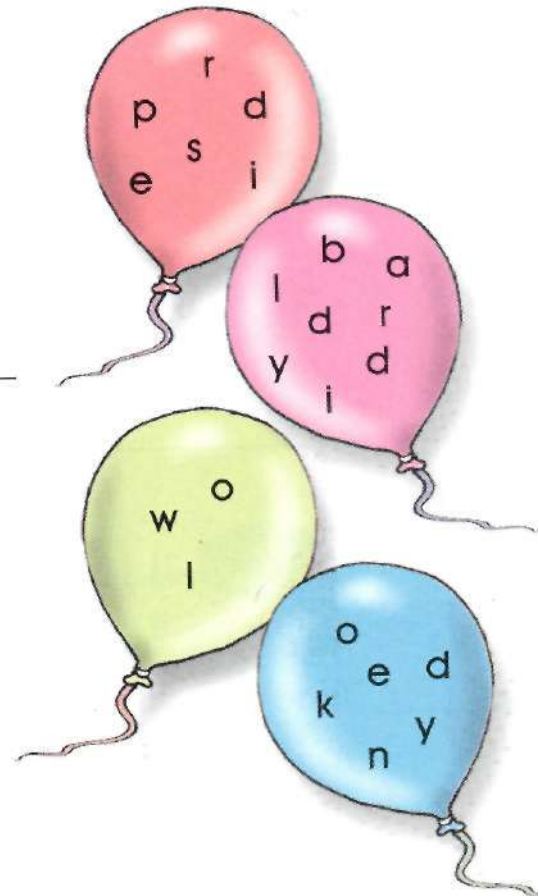

D Can you find 10 farm animals in the wordsearch?

B	C	K	W	A	S	P	N	Z	S
F	O	A	I	K	I	D	O	P	G
O	C	C	S	L	M	Y	M	X	L
A	K	D	U	C	K	L	I	N	G
L	E	B	D	B	C	R	O	W	R
R	R	U	C	H	I	C	K	P	T
Q	E	L	U	Q	E	O	C	A	K
T	L	L	W	P	R	C	A	N	X
H	O	R	S	E	Z	A	L	T	B
Y	G	O	O	S	E	J	F	A	S

- | | | |
|---|------|----|
| 1 | wasp | 6 |
| 2 | | 7 |
| 3 | | 8 |
| 4 | | 9 |
| 5 | | 10 |

E Look at the pictures and write the words to complete the letter.

Dear Ben,

Hi again.

So you want to know what I usually do on the farm.

In the morning, I



1) _____ the chickens, I

2) _____ the cows and I

3) _____ seeds.

In the afternoon, I



4) _____ in the fields or I

make _____ 5) _____



I hope you'll soon visit me.

Love,

Uncle John



Listen to the animals and write a number.

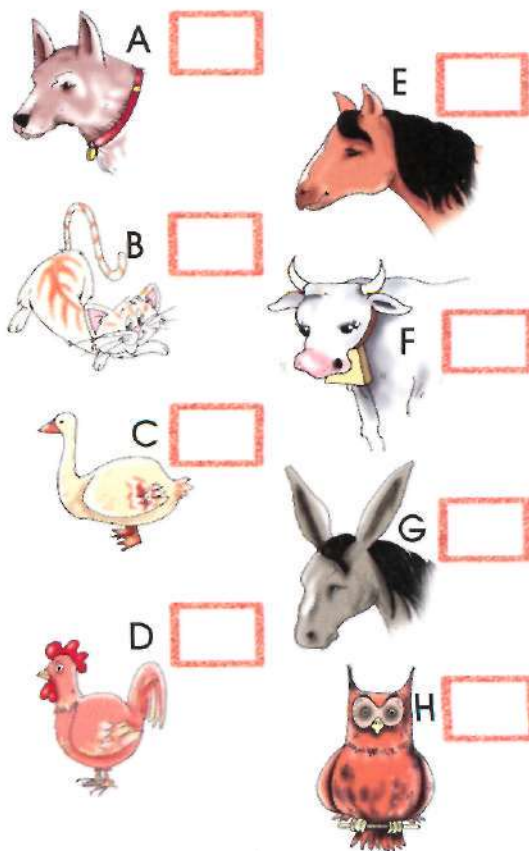

ANIMALS: AT THE ZOO

A

Look at the pictures and letters and write the words.

1



2



3



4

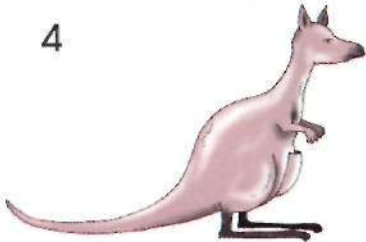

5



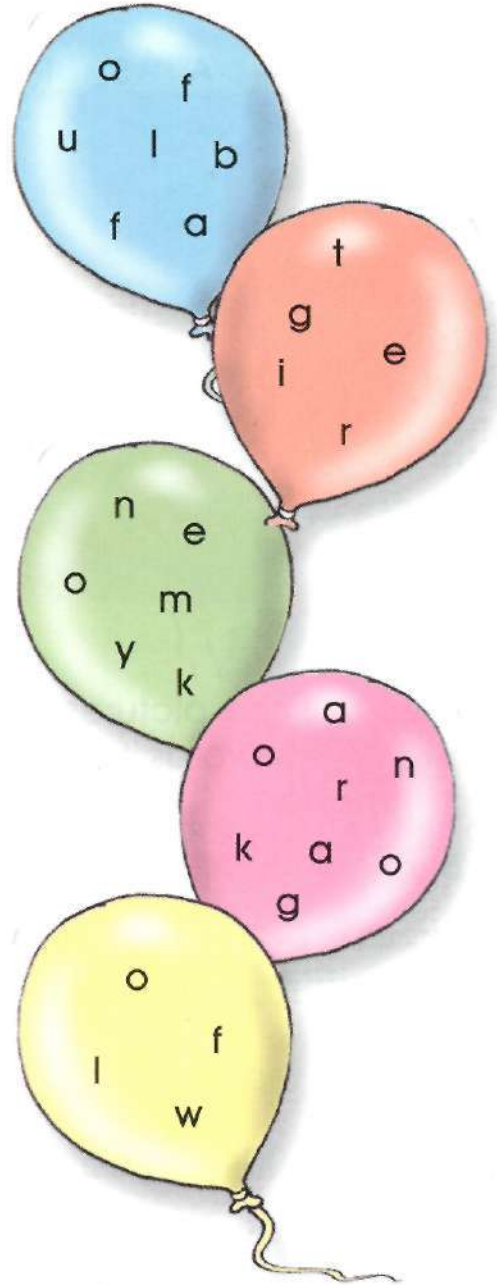

B

Which animals are these? Write the words.

1

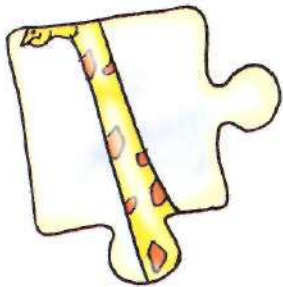

2

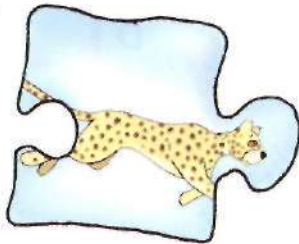

3



4

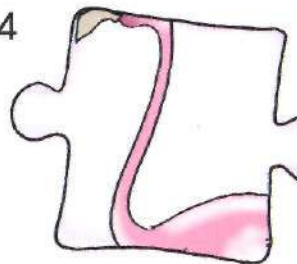

C Draw lines to match the words with the pictures.

hippopotamus
panther
camel
orangutan
ostrich
antelope

D Read and circle.

- 1 An elephant has got a _____.
A mane B trunk
- 2 A deer has got _____.
A antlers B humps
- 3 A lion has got a _____.
A hoof B mane
- 4 A camel has got a _____.
A tusk B hump

E Can you find 10 wild animals in the wordsearch?

H I P P O P O T A M U S O
G U H A U E S H O N U M L E
O O E I G A L L I G A T O R
R E L O G I R A F F E L R U
I V E P A L I B P A R R O T
L S P A A S D E S Y T O T K
L E H N T N G A M T I S C O
A U A D U A E R R A E L Z A
N T N A I K N E A G L E B L
W T T D A E O O S T T P A A

- 1 hippopotamus 6 _____
2 _____ 7 _____
3 _____ 8 _____
4 _____ 9 _____
5 _____ 10 _____

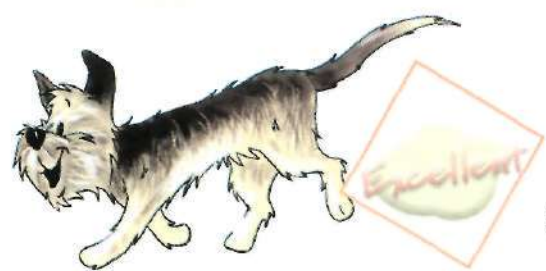

A Read and stick.



1 sea urchin



2 albatross



3 coral



4 tuna fish



5 seagull



6 eel

B Draw lines to join the words. Then match them with the pictures.

- | | |
|------------|--------|
| 1 humpback | urchin |
| 2 sea | fish |
| 3 tuna | bear |
| 4 polar | whale |

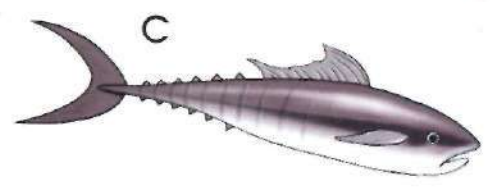
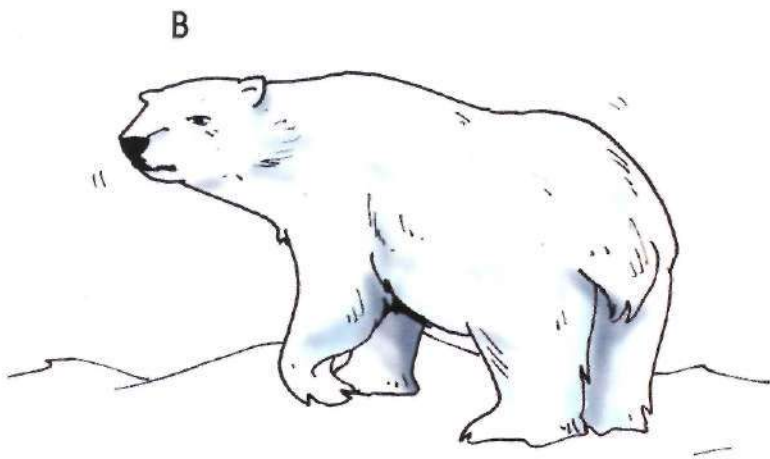
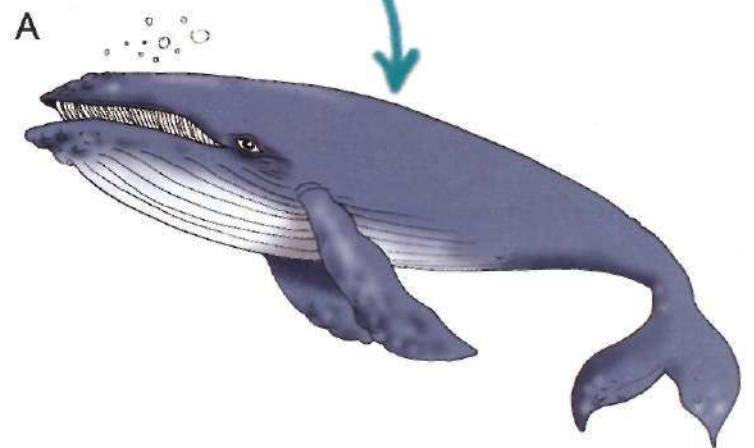

C Which of these are animals? Circle them.

air coral shell turtle
iceberg shrimp ray albatross crab
seal jellyfish seaweed eel
sea rock seahorse shark
shipwreck seabed
dolphin
tuna fish

D Draw these in the sea.

- 1 swordfish
- 2 seahorse
- 3 turtle
- 4 tuna fish
- 5 coral
- 6 shipwreck

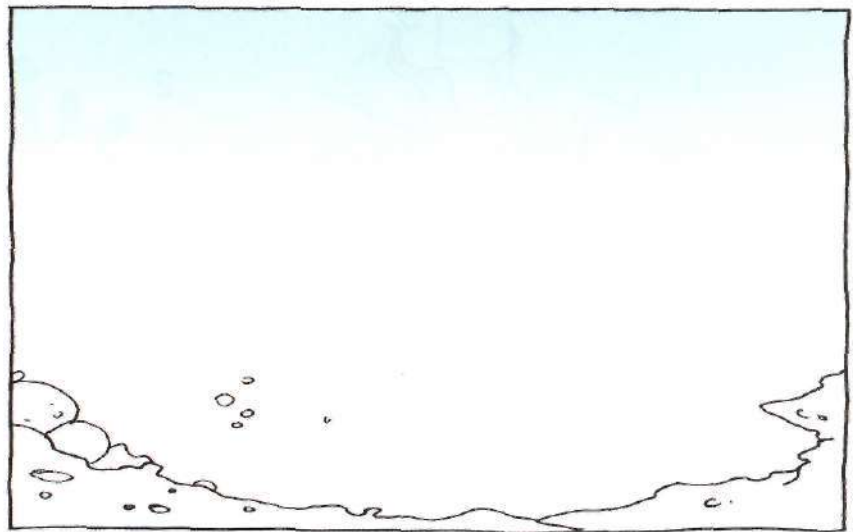

E Complete the puzzle. What's the hidden word?



A Draw lines to join the words.

cloud sun rain snow
snowy sunny
cloudy windy rainy wind

B Put the words in the correct list.

cold, sunny, hail, heatwave, blizzard, dry, icicle, hot

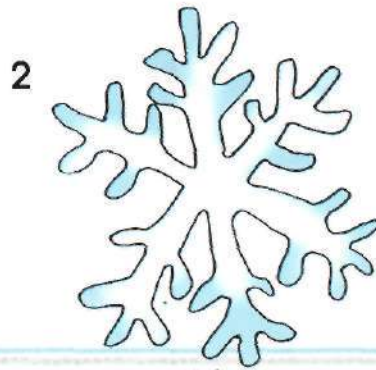
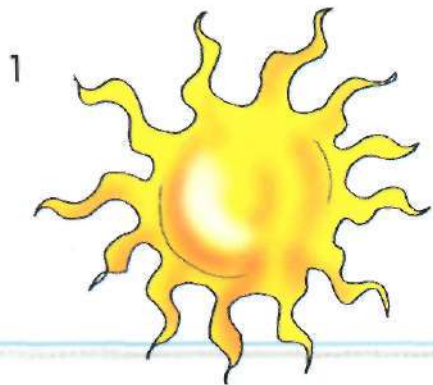

cold

_____	_____
_____	_____
_____	_____
_____	_____

C Read and stick.



1 cloud



2 lightning



3 mist

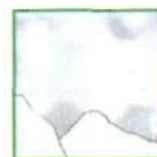

4 thunderstorm



5 icicle

D What's the weather like today? Draw a picture.



E Now, mark the temperature on the thermometer.

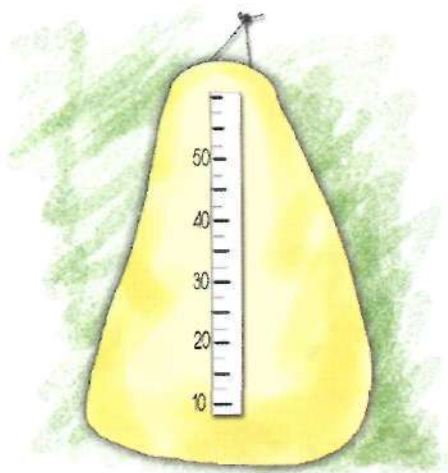

F What's the weather like? Listen and write a number.

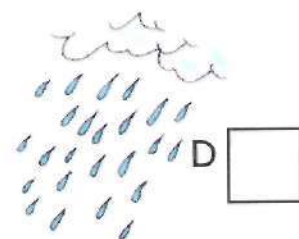
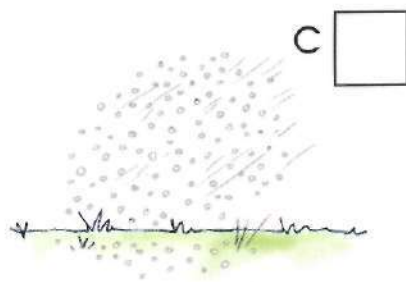
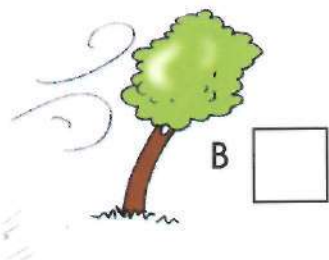
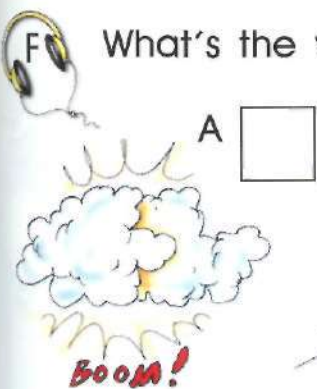

G What's the weather like? Look at the pictures and write.



It's _____

It's _____

It's _____

It's _____

H How many words can you find in the streamer?

ICEWEATHERFORECASTMISTPUDDLESNOWFLAKEFREEZINGHAILSTORMSKY



Brilliant



Label the map with the words.

Asia, Africa, Atlantic Ocean, North America,
Indian Ocean, Pacific Ocean, Europe, Australia, South America

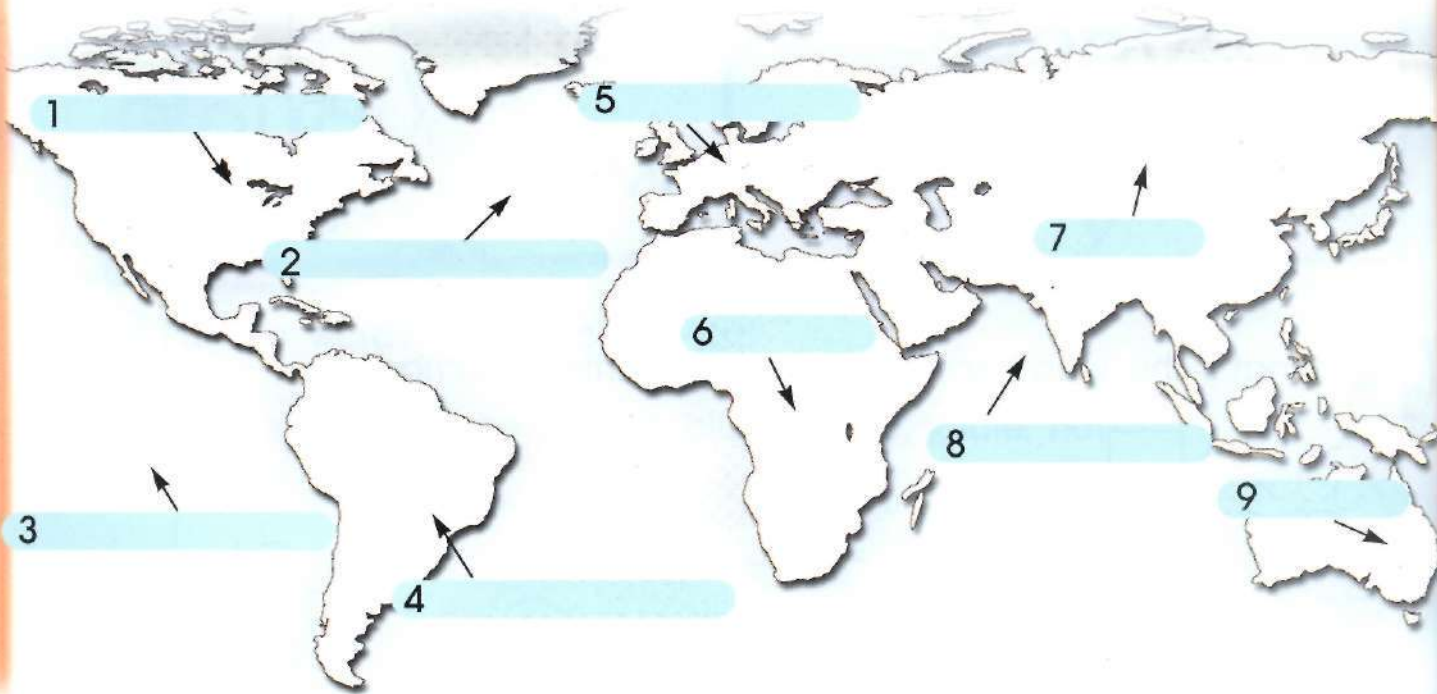

Draw lines to match the pictures with the words.

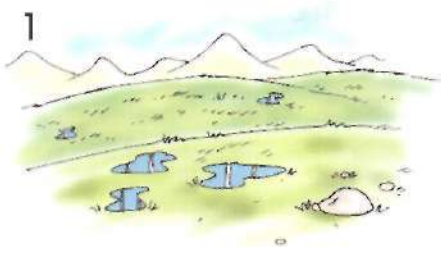

polar

tropical

mountain

desert

mediterranean

tundra

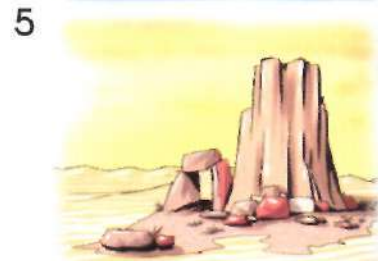

C Write the words in the correct list.

Africa, Polar, Desert, Atlantic, Europe, Antarctica, Arctic, Mountain, North America, Pacific, Continental

CONTINENTS	OCEANS	TYPES OF CLIMATE
Africa	_____	_____
_____	_____	_____
_____	_____	_____
_____	_____	_____

D What climate has your country got? Draw a picture.

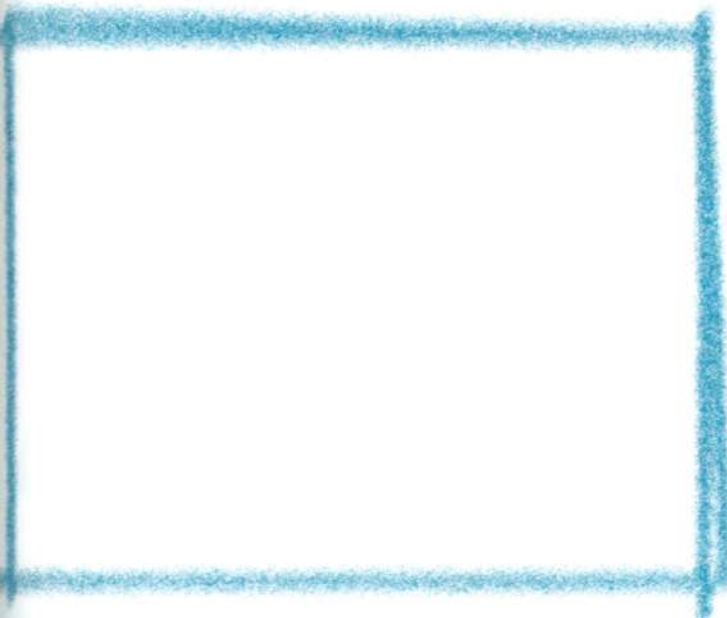

E Can you find 8 words in the wordsearch?

F A U S T R A L I A
 A H R I Y W R O D T
 B R C L S O U T H E
 O T L E I E A H O A
 C A I Q P E I S N S
 E K M U D A L G N T
 A Z A A Y N O R T H
 N Y T T I F S E L O
 S N E O D T E S D M
 I U R R M H W E S T

F How many words can you find in the streamer?



OUR WORLD: THE LANDSCAPE

A

Draw lines to match the pictures and the words.

1

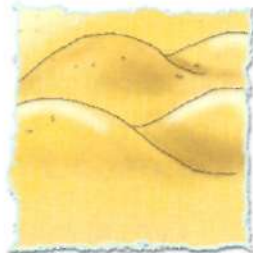

4



lake
forest
island



2

mountain range



3

sand dunes
waterfall



6



5

B

Circle the odd word out.

- | | | | | |
|---|-----------|--------|-----------|---------|
| 1 | waterfall | river | lake | peak |
| 2 | coast | beach | valley | bay |
| 3 | flood | forest | hurricane | drought |

C

How many words can you find in the streamer?

LANDSCAPE VOLCANIC ERUPTION OCEAN VALLEY TIDAL WAVE CLIFF

D

Read and draw.

1



mountain range

2



forest

3





beach

E Look at the pictures and the letters and write the words.

1  _____

2  _____

3  _____

4  _____

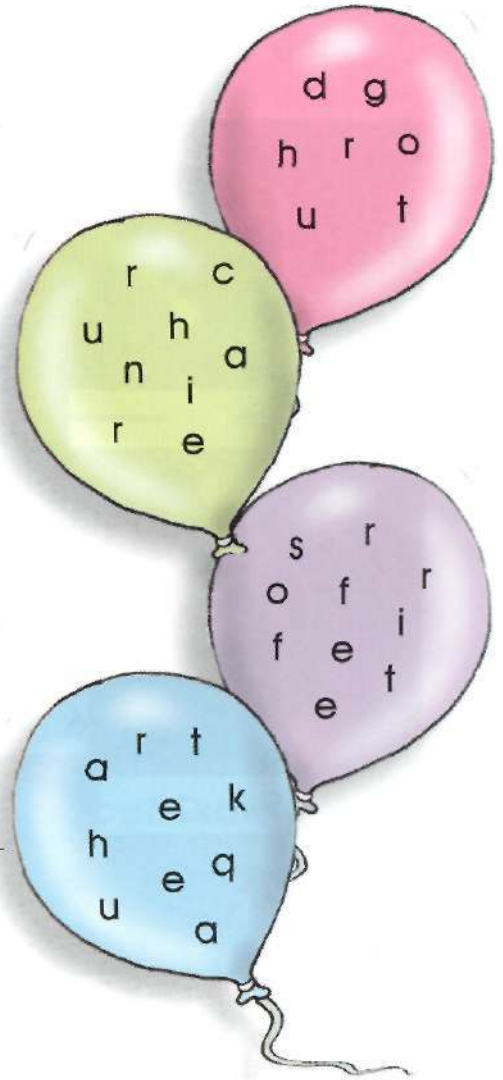

F Can you find 8 words in the wordsearch?

J	O	L	T	A	I	D	P	V
P	B	S	E	V	I	I	O	A
U	E	B	F	A	K	S	H	L
W	A	T	E	R	F	A	L	L
O	C	E	A	N	L	S	R	E
F	H	C	T	D	O	T	Q	Y
G	L	E	U	K	O	E	N	S
M	F	Z	R	Y	D	R	W	K
R	I	V	E	R	X	C	Y	U

- 1 beach _____ 5 _____
- 2 _____ 6 _____
- 3 _____ 7 _____
- 4 _____ 8 _____



OUR WORLD: THE SOLAR SYSTEM

A Label the picture with the words.

the Sun, Neptune, Mercury, Earth, Venus, Pluto, Uranus, Mars, the Moon, Saturn, Jupiter

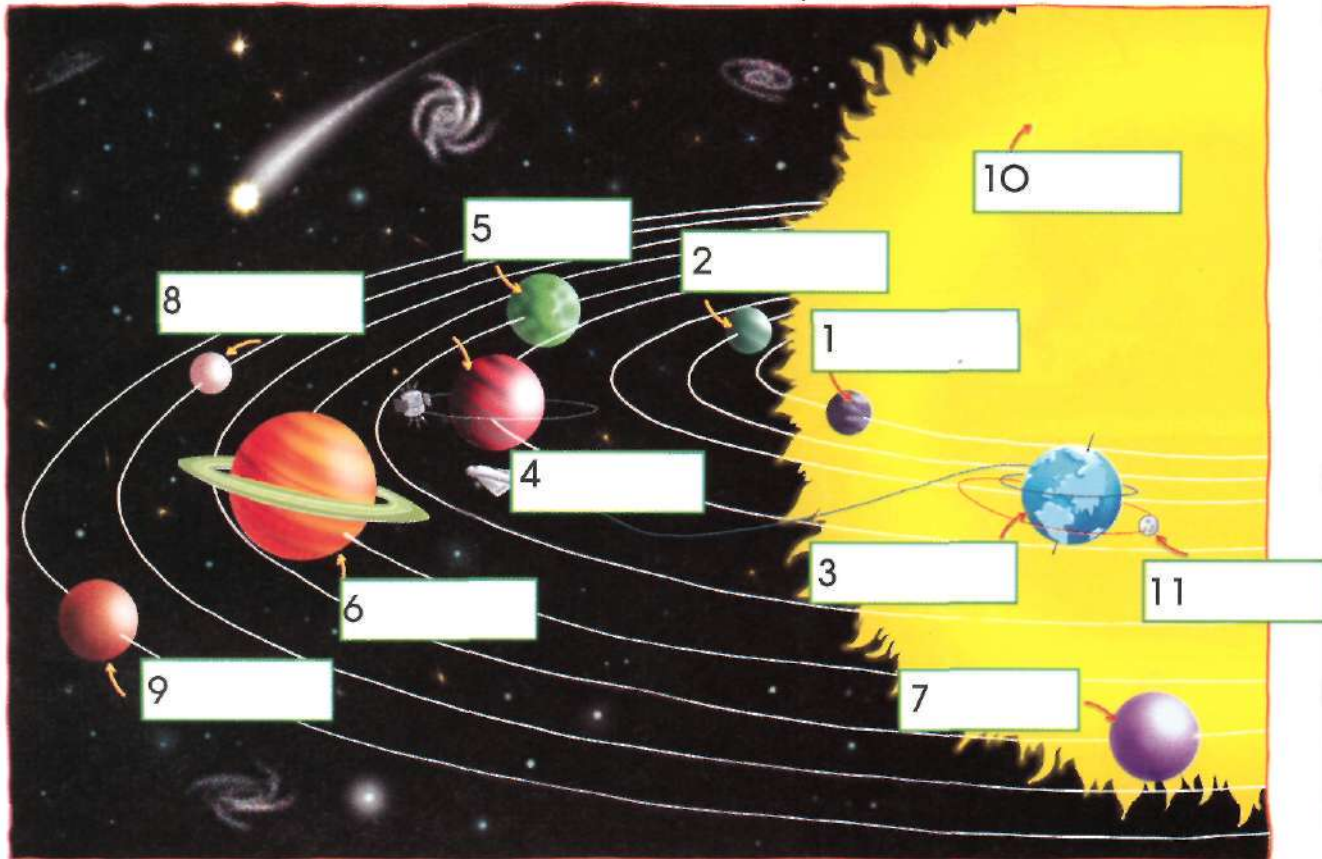

B Put the planets in order. Begin from the one nearest to the sun and end with the one furthest away from it.

Earth Uranus Jupiter Mars Saturn
 Mercury Venus Pluto Neptune

Mercury, _____

C Read and circle.

- | | |
|---------------------------------------|--------------------------------------|
| 1 The Sun is a _____. | 3 The _____ is the planet on |
| A star B planet | which we live. |
| 2 The sun and all the planets which | A Moon B Earth |
| move around it is the | 4 The only planet with rings around |
| _____ system. | it is _____. |
| A solar B planet | A Mars B Saturn |

D Can you find 9 words in the wordsearch?

U	R	A	N	U	S	O	J	N
O	M	W	L	S	T	V	U	A
E	E	N	P	A	L	E	P	A
R	R	H	O	W	L	N	I	M
M	C	C	E	P	L	U	T	O
A	U	U	E	I	E	S	E	T
R	R	E	A	R	T	H	R	I
S	Y	S	A	T	U	R	N	T
N	E	P	T	U	N	E	H	T

- | | | |
|---|--------|---|
| 1 | Uranus | 6 |
| 2 | _____ | 7 |
| 3 | _____ | 8 |
| 4 | _____ | 9 |
| 5 | _____ | |

E What do you think the Earth looks like from space? Draw a picture.





OUR TOWN: TRANSPORT



A Put the words in the correct list.

~~helicopter~~ hydrofoil
 tram train motorbike
 speedboat hot-air balloon
 aeroplane hovercraft

By

Air

Sea

Land

helicopter

B Look at the pictures and letters and write the words.

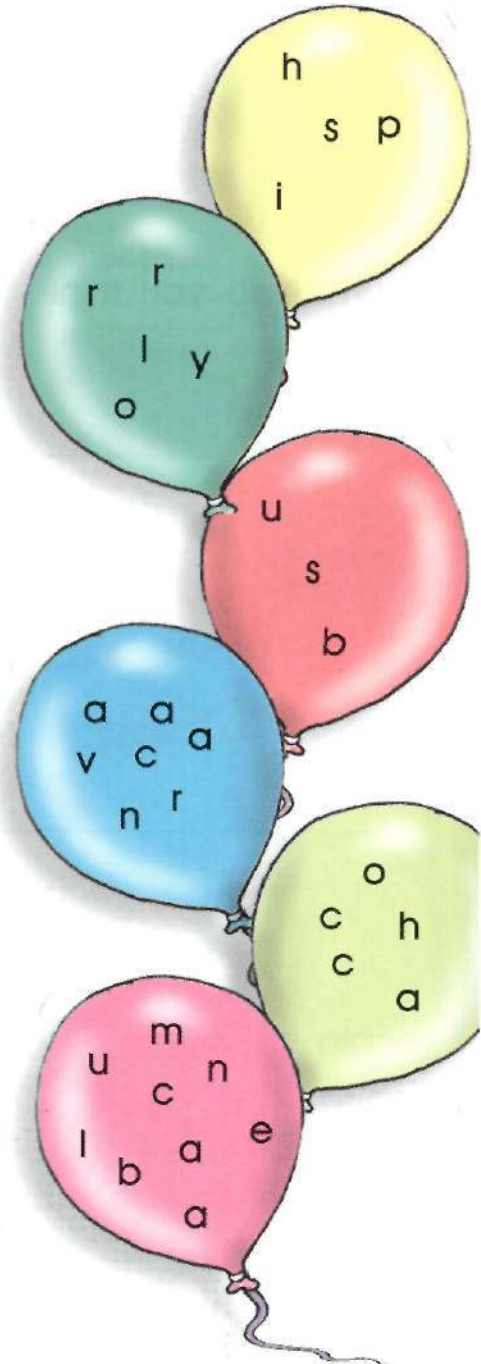
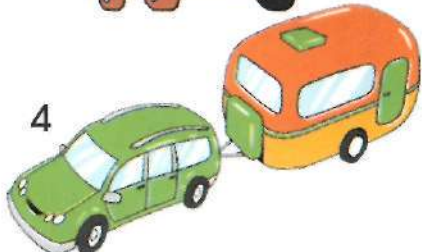
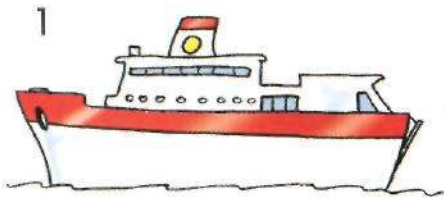

C

Can you find 12 words in the wordsearch?

T	S	P	E	E	D	B	O	A	T
R	M	O	T	O	R	W	A	Y	H
A	B	U	O	S	T	A	P	C	Y
C	L	L	T	R	A	I	N	A	D
T	O	B	I	S	I	T	S	R	R
O	R	O	B	F	V	Q	H	A	O
R	R	F	U	R	E	T	I	V	F
T	Y	K	S	S	E	B	P	A	O
R	E	C	O	A	C	H	O	N	I
A	C	A	R	P	A	R	K	A	L
A	E	R	O	P	L	A	N	E	T

- | | | | |
|---|------------------|----|-------|
| 1 | <u>speedboat</u> | 7 | _____ |
| 2 | _____ | 8 | _____ |
| 3 | _____ | 9 | _____ |
| 4 | _____ | 10 | _____ |
| 5 | _____ | 11 | _____ |
| 6 | _____ | 12 | _____ |

D

Read and circle.

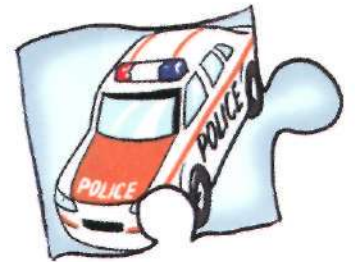

1 This is a hovercraft.
Yes / No

2 This is a caravan.
Yes / No

3 This is a lorry.
Yes / No

4 This is an ambulance.
Yes / No

5 This is a speedboat.
Yes / No

E

Draw lines to join the words.

- | | |
|---------------|---------|
| 1 car | train |
| 2 police | balloon |
| 3 underground | engine |
| 4 hot-air | park |
| 5 fire | car |



OUR TOWN: ON THE ROAD

A Look at the pictures and letters and write the words.









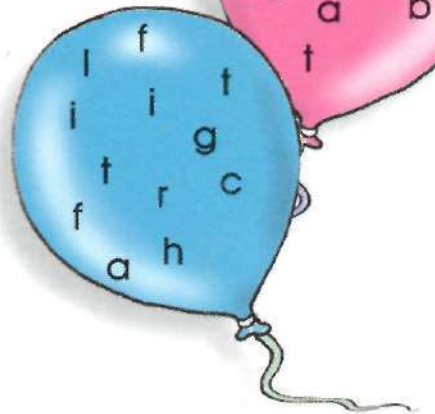
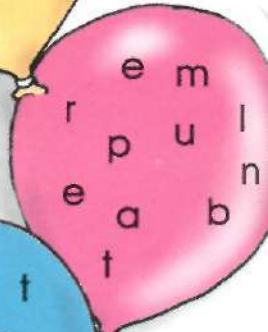
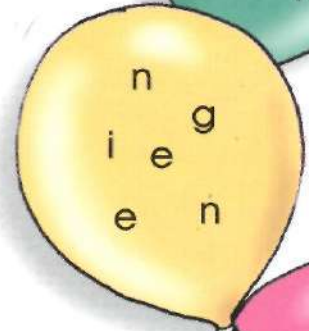
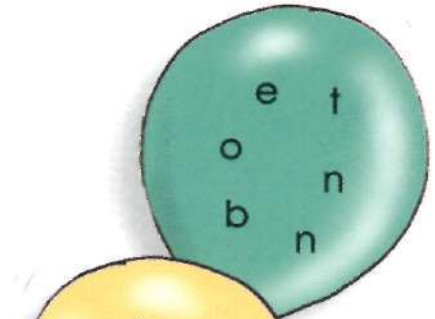

B What are these? Write the words.



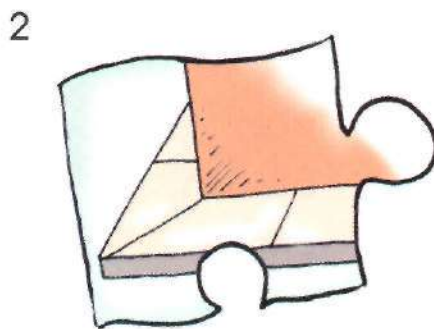



C Draw lines to join the words. Then match the words with the pictures.

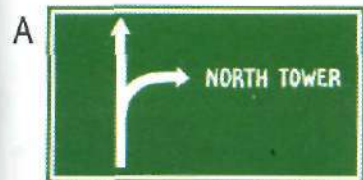

- 1 petrol
- 2 lamp
- 3 bus
- 4 traffic
- 5 road

- sign
- warden
- pump
- stop
- post

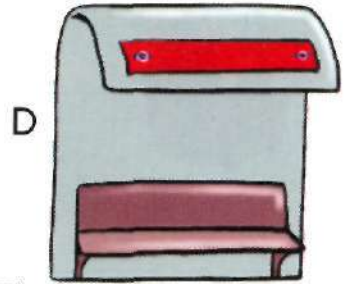

D Read and draw.



a motorway



a pedestrian crossing

E Can you find 8 words in the wordsearch?

E	S	B	O	N	N	E	T	G	M
P	C	O	G	T	U	U	O	N	G
P	U	O	O	S	E	Z	L	A	B
A	A	T	H	C	O	R	N	E	R
V	C	I	N	S	T	Y	L	E	I
E	R	R	O	T	N	R	R	P	D
M	O	T	O	R	W	A	Y	A	G
E	A	E	T	E	V	L	A	N	E
N	D	E	E	E	N	M	E	E	A
T	U	T	O	T	L	R	L	U	T

- 1 _____
- 2 _____
- 3 _____
- 4 _____
- 5 _____
- 6 _____
- 7 _____
- 8 _____





OUR TOWN: MAIN STREET

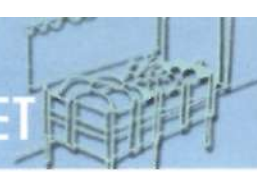

A

Write the people's jobs. Then match them to the place where they work.

1



g r e e n g r o c e r

2



3



4



5



A

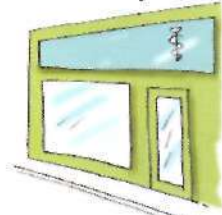

B



C



D



E



B

Look at the pictures and letters and write the words.

1

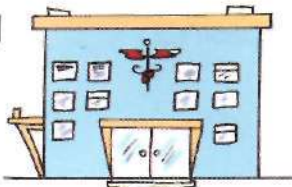

2



3



4



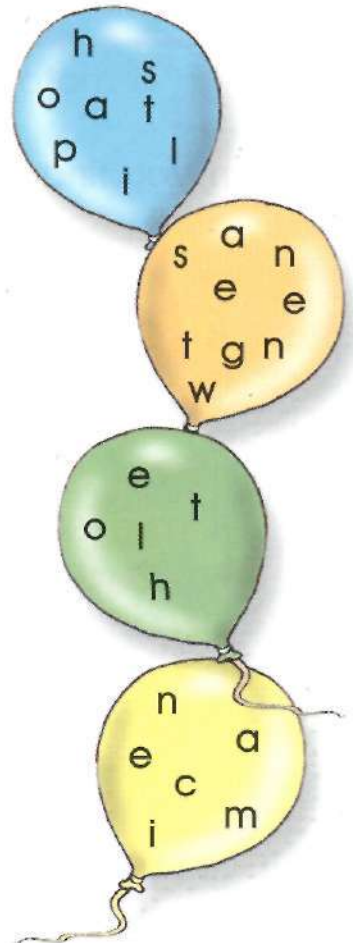

C Read and circle.

1 You can buy stamps at the post office.

(Yes) / No

2 You can watch a film at the cinema.

Yes / No

3 You can buy medicine at the bank.

Yes / No

4 You can buy lots of different food at the supermarket.

Yes / No

5 You can buy meat at the baker's.

Yes / No

6 You can borrow books from the library.

Yes / No

D Circle the odd word out.

1 village

town

hospital

city

2 café

butcher's

baker's

chemist's

3 refuse collector

gym

newsagent

librarian

4 office building

hotel

shopping centre

greengrocer

E Where do these people have to go? Listen and draw lines.

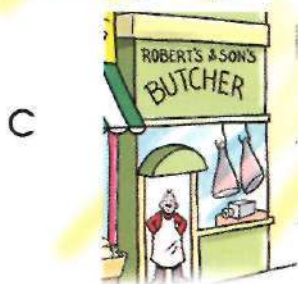

OUR TOWN: IN A SHOPPING CENTRE

A Draw lines to match the words with the pictures.



CD shop
 video shop
 bookshop
 toy shop
 fast food restaurant
 pet shop

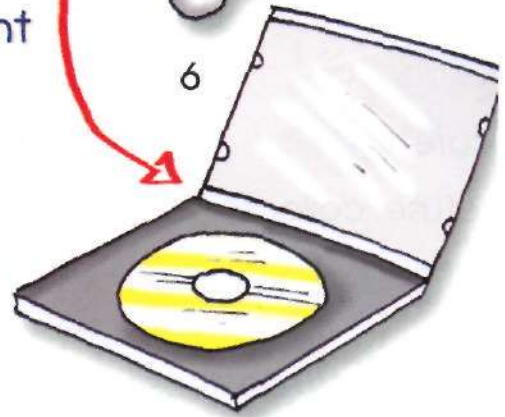
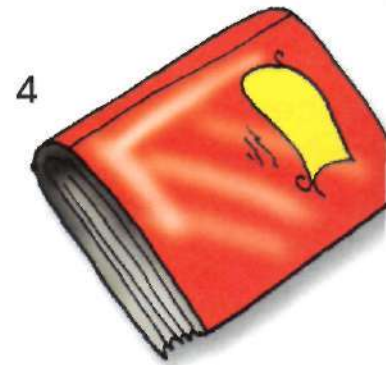

B Look at the picture and tick (✓) what you can see.

- 1 escalator
- 2 florist
- 3 travel agent's
- 4 phone booth
- 5 CD shop
- 6 clothes shop
- 7 card shop
- 8 information desk



C Read and write.

YOU CAN BUY ...

1  at the clothes shop.

2  at the _____.

3  at the _____.

4  at the _____.

5  at the _____.

D Write the people's jobs.

1  _____

2  _____

3  _____

4  _____

E Can you find 9 words in the wordsearch?

S	O	B	O	O	K	S	H	O	P	T	J
H	T	O	Y	S	H	O	P	B	P	G	E
O	D	B	T	K	W	Q	C	J	E	Y	W
E	S	C	A	L	A	T	O	R	T	L	E
S	A	I	N	U	C	G	I	E	S	H	L
H	G	O	H	S	D	I	O	X	H	O	L
O	P	T	I	C	I	A	N	R	O	P	E
P	F	L	O	R	I	S	T	N	P	A	R
T	R	A	V	E	L	A	G	E	N	T	L



OUR TOWN: AT THE CLINIC

A

Draw lines to match the pictures with the words.

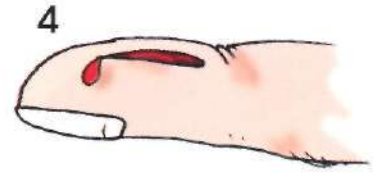
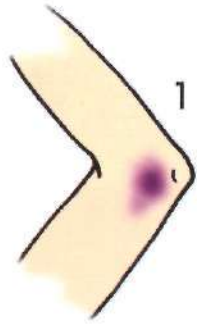

bruise
temperature
cut
sore throat
earache
headache



B

Look at the pictures and letters and write the words.











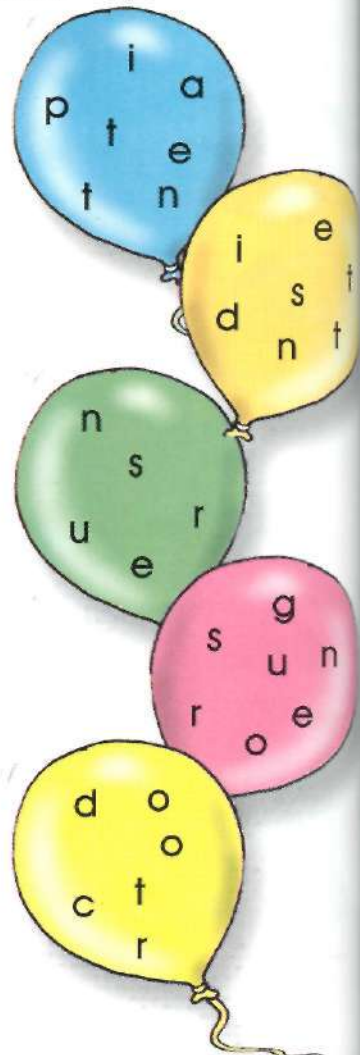

C Draw lines to match the pictures with the words.

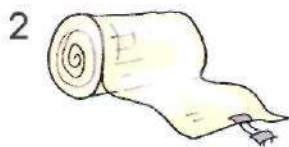

sticking plaster
first aid kit
wheelchair
medicine
thermometer
bandage
cast

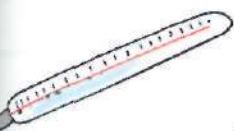

D Complete the puzzle and find the hidden expression.

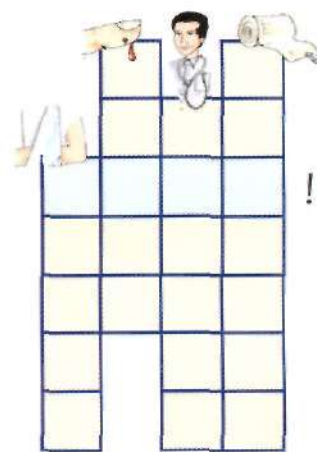
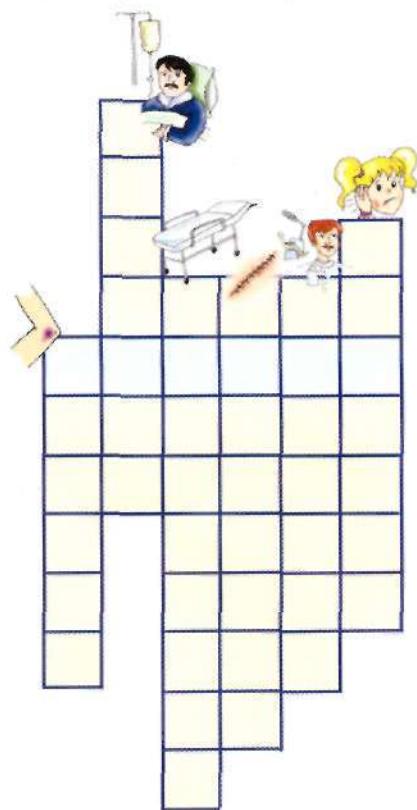
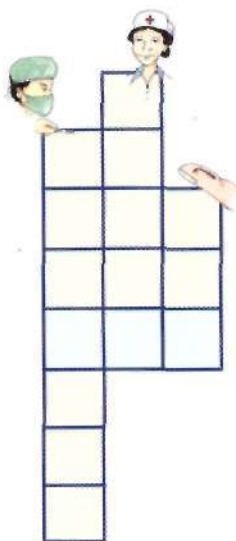

E Why are these people at the clinic? Listen and write a number.

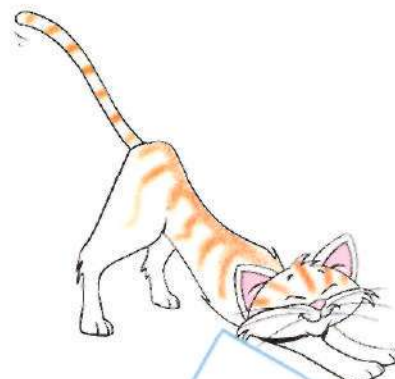
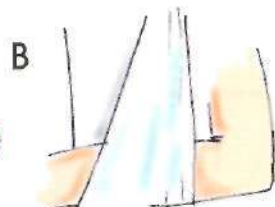
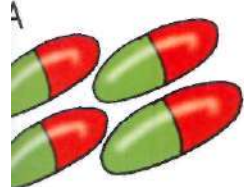

WORDS: OPPOSITES



Match the words in the boxes with their opposites.

there, smooth, old, right, light, blunt, old-fashioned,
bad, strong, sweet

1 young	_____
2 sharp	_____
3 good	_____
4 here	_____
5 heavy	_____

6 _____	wrong
7 _____	rough
8 _____	sour
9 _____	modern
10 _____	weak



Look at the pictures and complete the puzzle with opposites. What is the hidden expression?

full, closed, high, blunt, quiet, expensive, difficult, dark, weak, long, different, fat, right, dirty

$\sqrt{\frac{2x-4}{21}} - \sqrt{\frac{3y}{2}} =$
 $2 \times 4 = 8$

C Look at the pictures and circle the correct word.



A strong / weak boy.



A heavy / light feather.

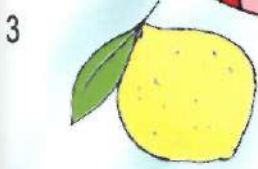

A sweet / sour lemon.



A(n) old / new car.

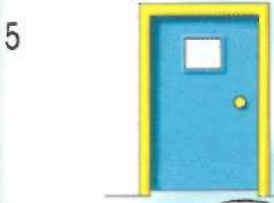

A closed / open door.



A small / big elephant.

D Draw lines to match the words with the pictures.

right, slow, front, false, short

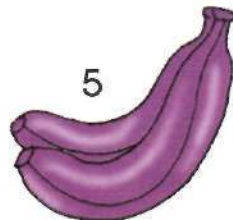
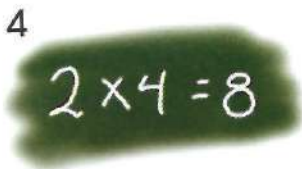
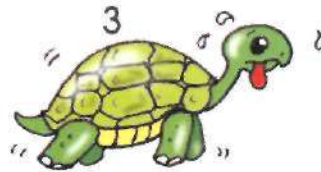

WORDS: AT THE PLAYGROUND

A Draw lines to match the words with the pictures.

A **B** **C** **D** **E** **F**

between
 under
 next to
 on top of
 behind
 above

B Draw lines to join the words.

1 at the to
 2 in bottom of
 3 next top of
 4 at the front of

C Look at the picture and use the words to complete the sentences.

next to, in front of, under, behind

- The yellow book is _____ the teacher.
- The orange book is _____ the table.
- The purple book is _____ the vase.
- The brown book is _____ the chair.

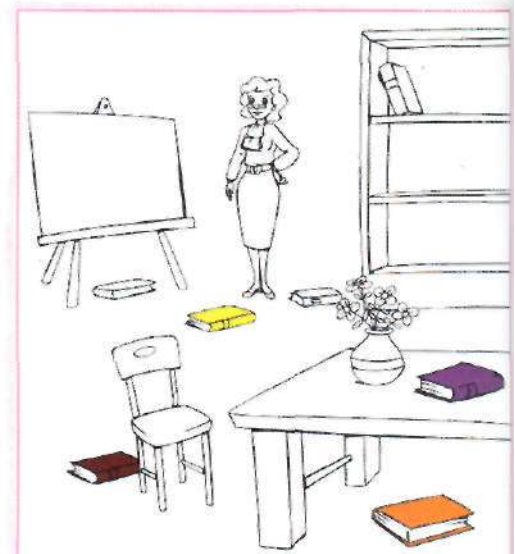



Look at the picture. Then, read and circle.

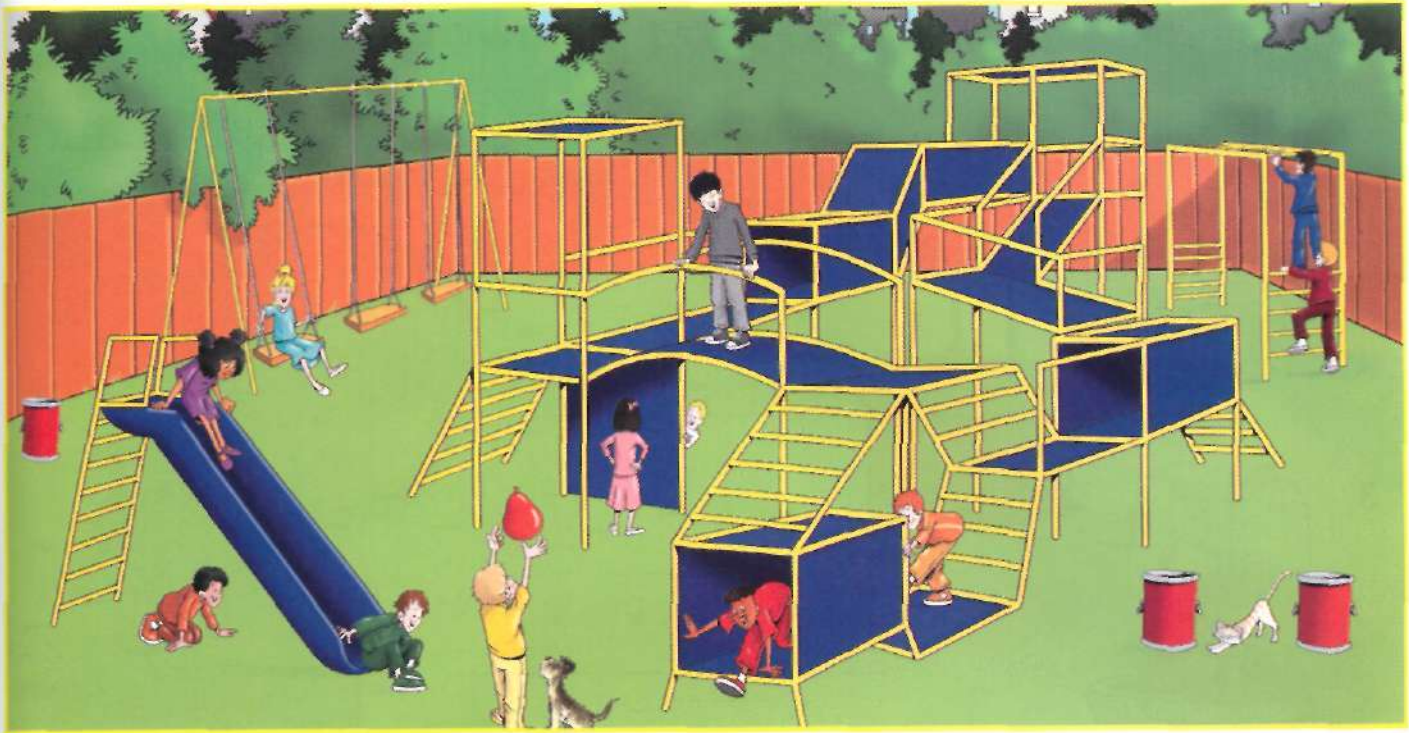

- | | |
|--|----------|
| 1 The cat is between the bins. | Yes / No |
| 2 The girl in blue is next to the swing. | Yes / No |
| 3 The girl in pink is in front of the wall. | Yes / No |
| 4 The boy in green is at the top of the slide. | Yes / No |
| 5 The boy in brown is under the slide. | Yes / No |
| 6 The dog is behind the boy in yellow. | Yes / No |
| 7 The boy in grey is in the box. | Yes / No |



Where are they? Listen and draw lines.

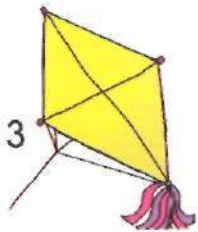
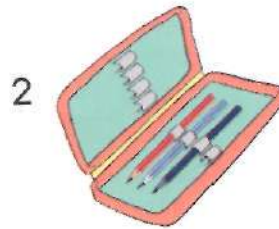

- in the garden
- in the drawer
- on the kitchen table
- at the top of the slide
- under the chair



WORDS: IN THE MAZE

A

Look at the pictures and letters and write the words.

1



2



3



4

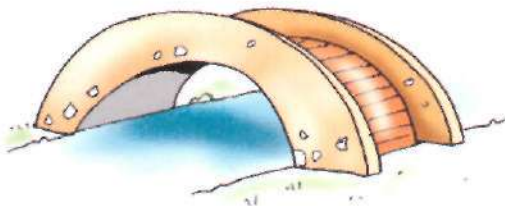

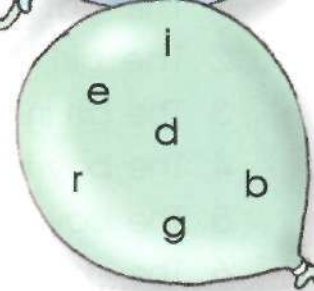
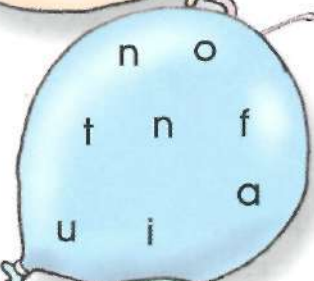
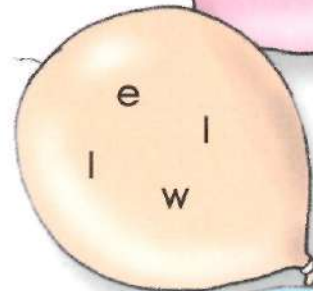
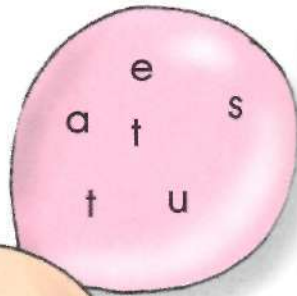

B

Draw lines to match the words with the pictures.

1

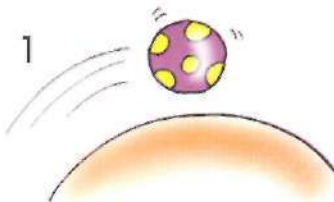

2



3

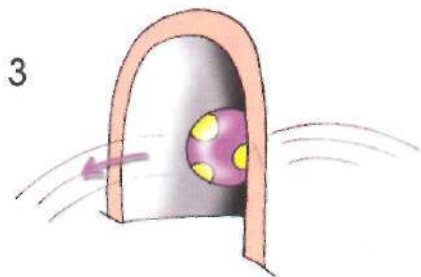

- into
- along
- towards
- over
- through
- across

4

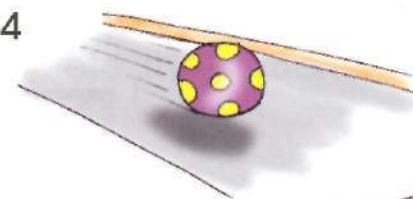

5

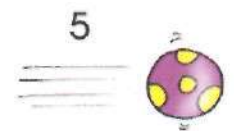

6

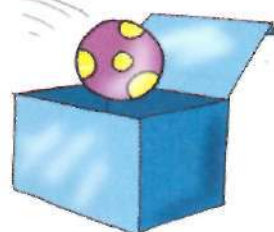

C

Look at the pictures and use the words to complete the sentences.

towards, past, up, round



1 He is walking _____ the statue.



He is running _____ the fountain. 2



3 He is going _____ the hill.



He is walking _____ the well. 4

D

How many words can you find in the streamer?



E

Listen and write a number.

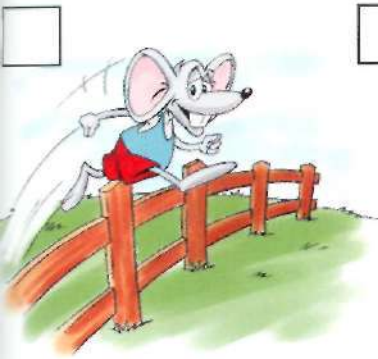

A

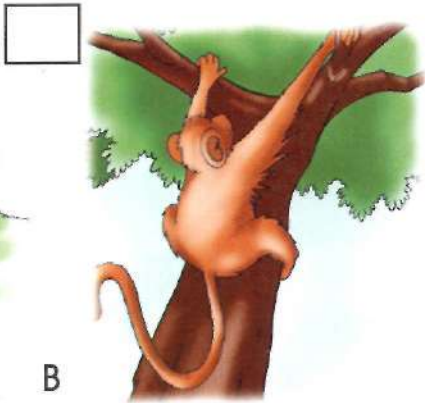

B



C



WORDS: A SUMMER CAMP

A What are they doing? Draw lines to match the pictures with the sentences.



She's drinking some water.

He's washing up.

She's sleeping.



He's eating a burger.

He's closing the door.

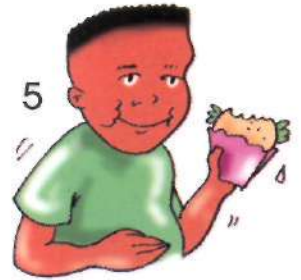

B Draw lines to join the words.

- | | |
|--------|---------|
| 1 tie | down |
| 2 get | away |
| 3 make | up |
| 4 put | on |
| 5 sit | the bed |
| 6 turn | dressed |

C Read and draw.

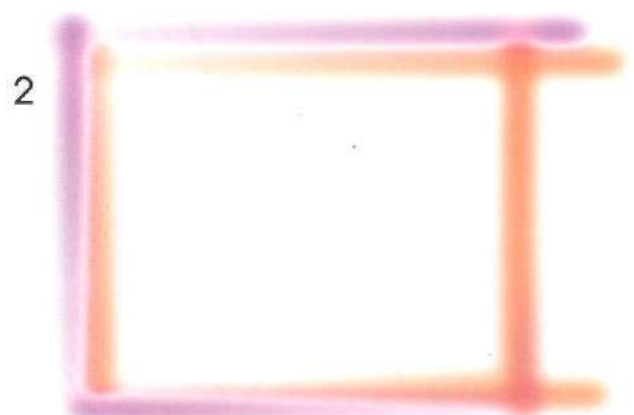
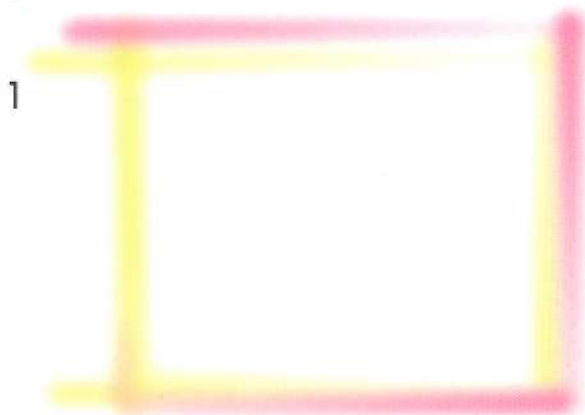

a boy yawning

a girl setting the table

D Can you find 8 verbs in the wordsearch?

T	I	A	B	R	U	S	H	D
U	E	S	P	M	L	I	F	T
R	Y	N	U	A	I	E	S	D
N	A	S	T	R	E	T	C	H
O	W	B	A	P	W	S	W	H
N	N	D	W	R	A	F	I	U
O	F	O	A	H	S	M	O	P
T	B	L	Y	L	H	T	I	S

- | | | | |
|---|-------|---|-------|
| 1 | brush | 5 | _____ |
| 2 | _____ | 6 | _____ |
| 3 | _____ | 7 | _____ |
| 4 | _____ | 8 | _____ |

E Listen and draw lines.

Pamela

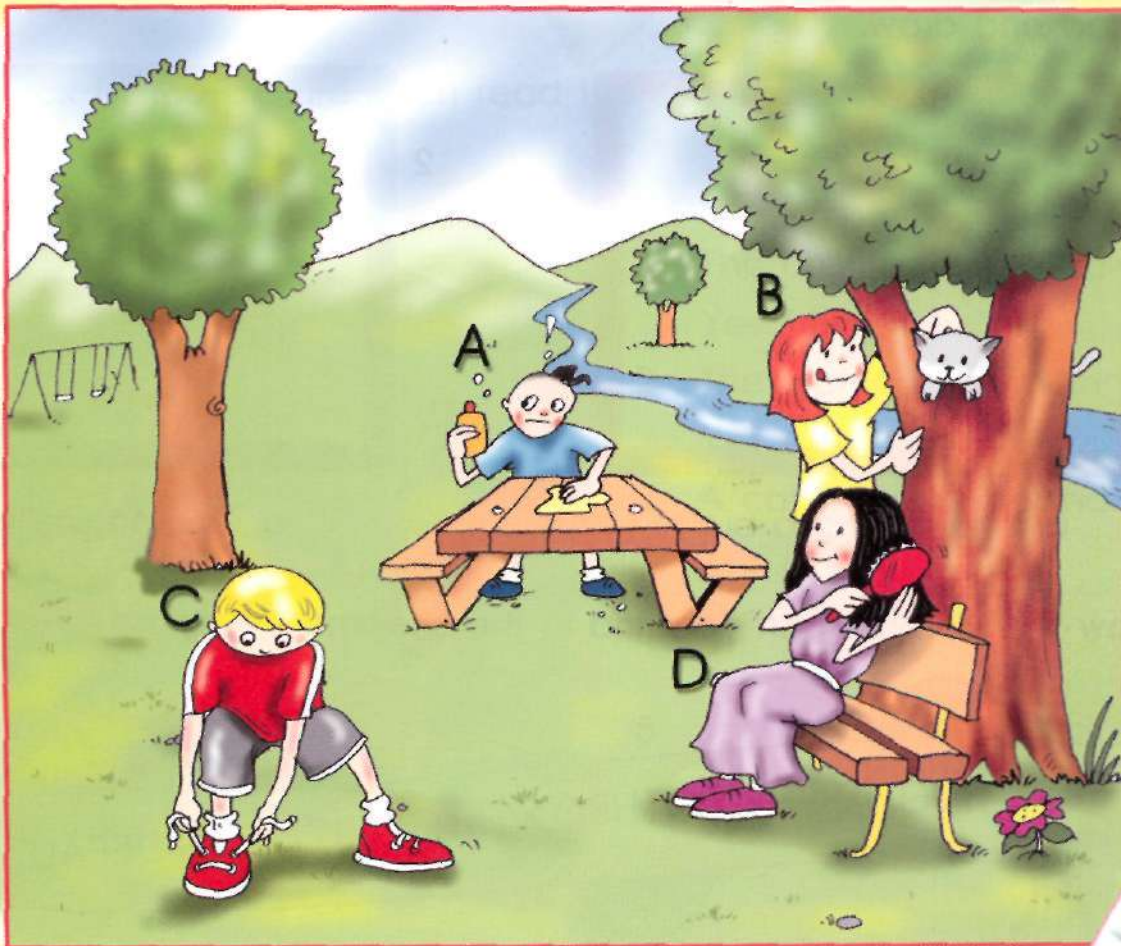

drian

Jane

Jerry



A

What are they doing? Draw lines to match the pictures with the sentences.



She's hitting the ball.

She's watering the flowers.

She's cycling.

He's throwing the ball.

He's buying some ice cream.

4



3



5



B

Read and draw.

1



2

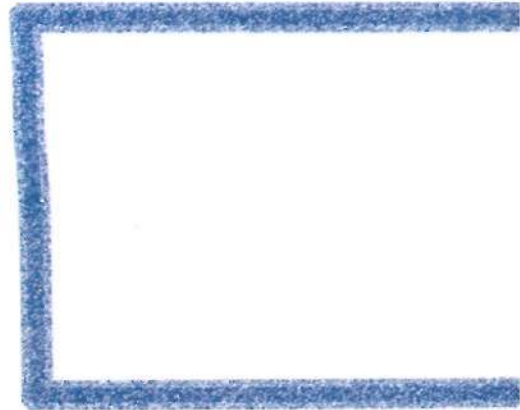

a man driving a bus

a woman smiling

C

How many verbs can you find in the streamer?

CARRY GIVE LAUGH PUSH THROW HIT CYCLE KICK HIDE FALL

 Listen and draw lines.



Andrew
Carole
Allson
Dan
Pat

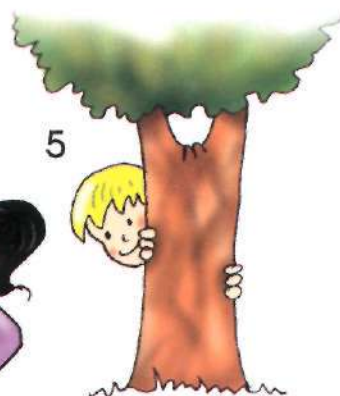

 Look at the picture. Then read the sentences and circle.



- 1 The children are hugging.
Yes / No
- 2 The woman is climbing a tree.
Yes / No
- 3 A cat is hiding behind a tree.
Yes / No
- 4 The baby is waving.
Yes / No
- 5 The man is digging.
Yes / No



FUN: AT THE BEACH

A Look at the pictures and letters and write the words.





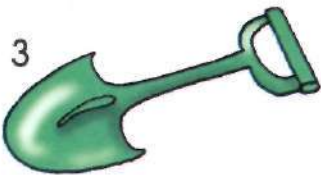





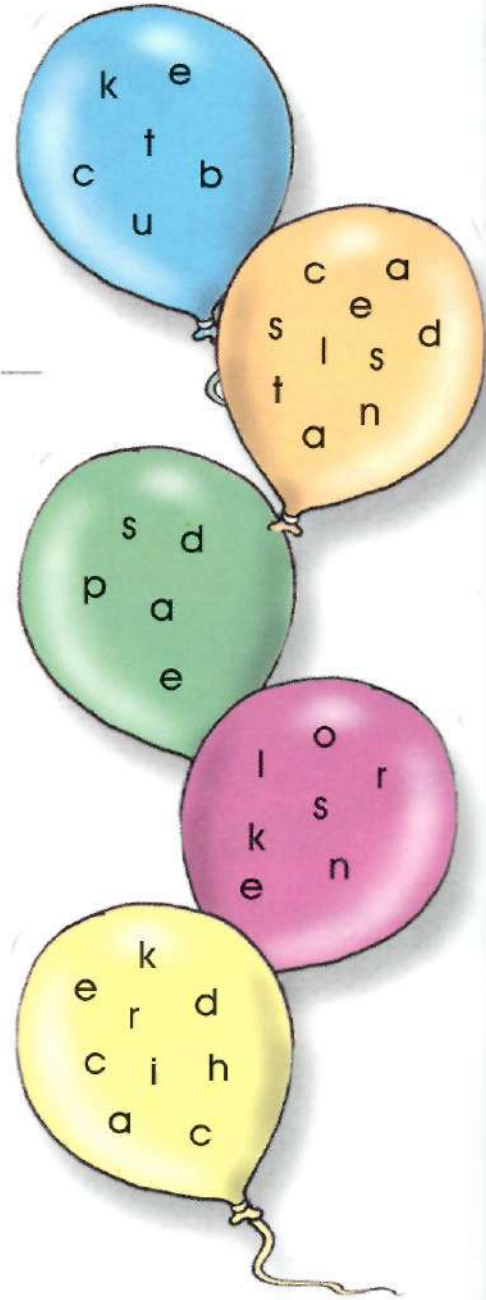

B What are these? Write the words.

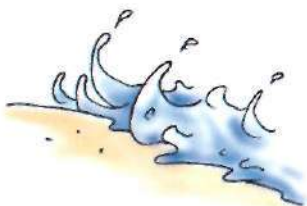

1 -----

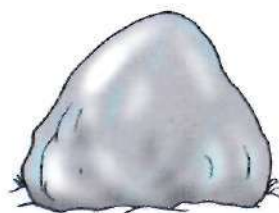

2 -----

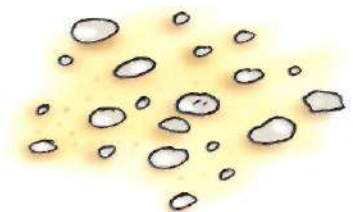

3 -----

C Read and draw.

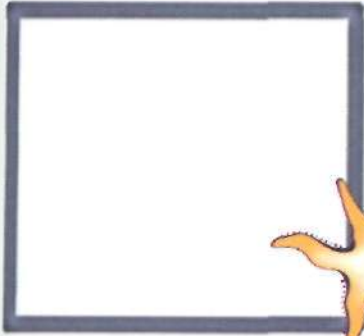

1 a beach umbrella



2 two armbands

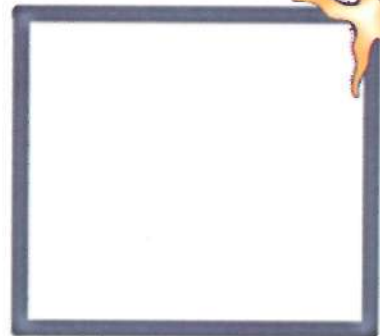

3 two flippers

D Listen, draw and colour.

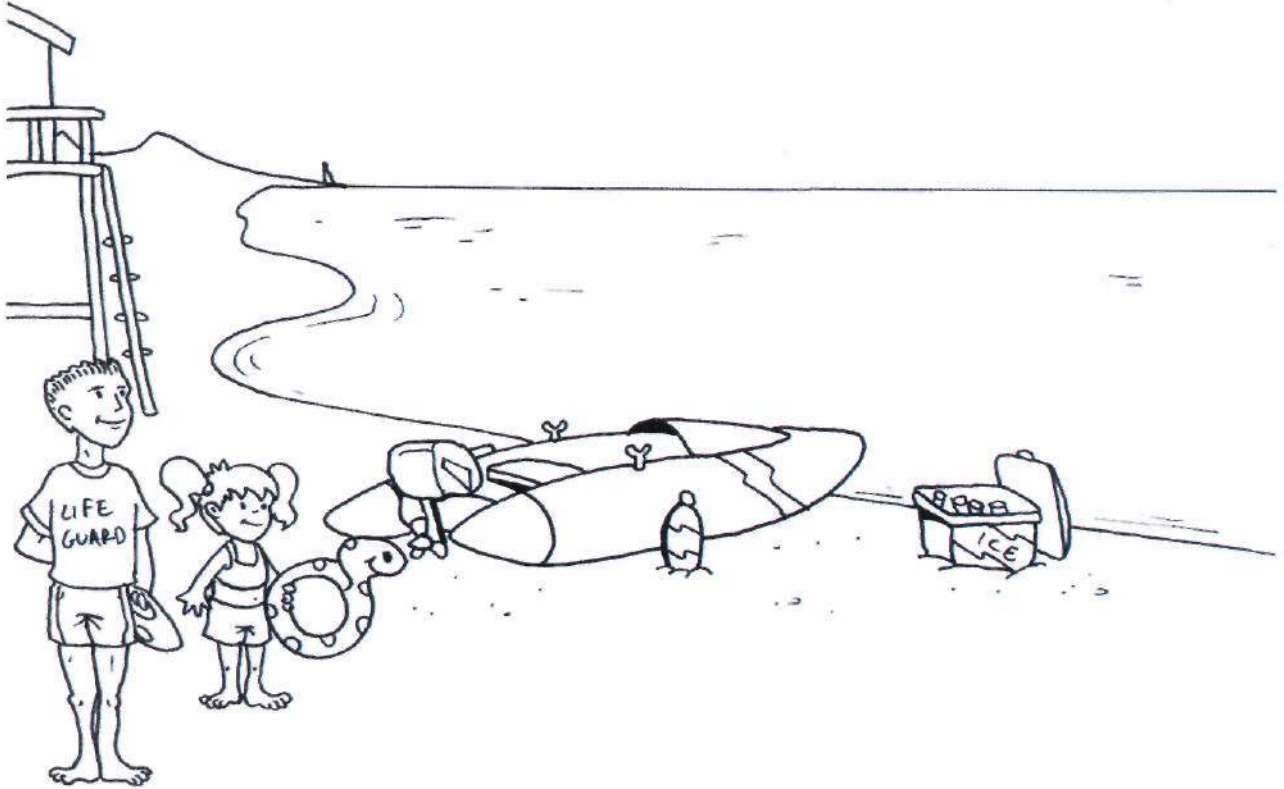

E Draw lines to join the words. Then match them with the pictures.

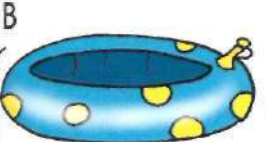

- 1 beach
 - 2 diving
 - 3 rubber
 - 4 beach
- ring
 - volley
 - mat
 - mask





Draw lines to join the words.

- 1 zoo
- 2 funfair
- 3 sports event
- 4 ballet
- 5 natural history museum
- 6 theatre
- 7 cinema
- 8 exhibition

- candyfloss
- dancer
- play
- zoo keeper
- screen
- sculpture
- team
- dinosaur

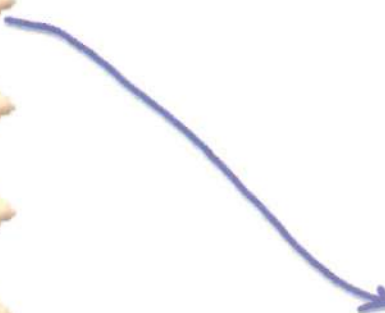

What are these? Write the words.



1 _____

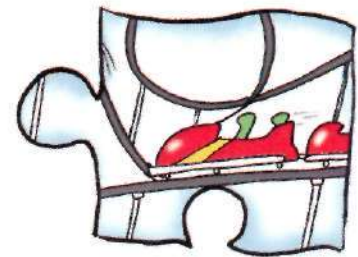

2 _____



3 _____

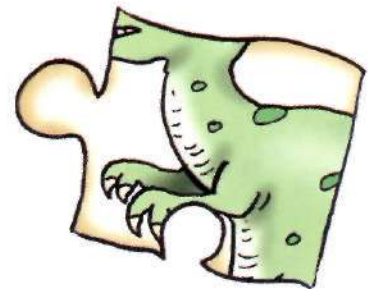

4 _____



Where am I? Listen and write a number.

- A at the funfair
- B at the natural science museum

- C at an exhibition
- D at the cinema
- E at a sports event



Circle the odd word out.

- | | | | |
|-------------|----------------|----------|---------|
| 1 fans | audience | team | exhibit |
| 2 big wheel | roller-coaster | painting | dodgems |
| 3 orchestra | screen | film | cinema |
| 4 zookeeper | dinosaur | dancer | usher |



What do you like to do in your leisure time? Draw and colour.

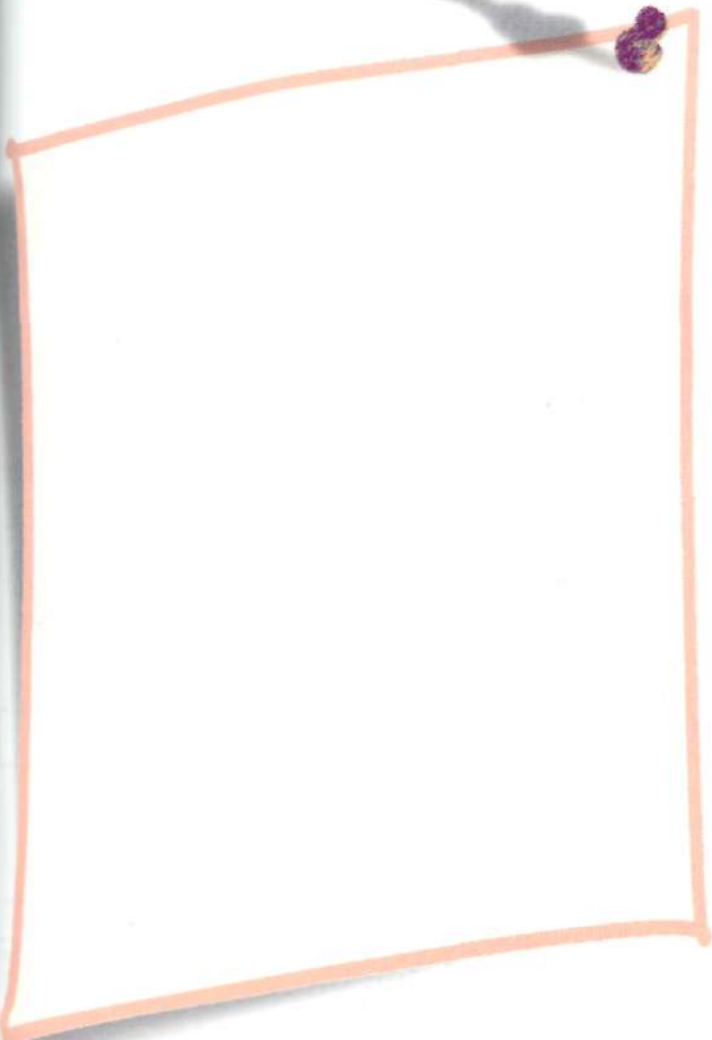

Can you find 8 words in the wordsearch?

Z	I	K	E	R	V	A
O	F	A	N	S	E	L
O	U	S	H	E	R	F
L	N	I	O	E	S	O
G	F	I	L	M	C	Q
D	A	N	C	E	R	I
T	I	O	R	I	E	S
W	R	G	K	N	E	U
S	T	A	G	E	N	V
E	F	K	N	P	Y	Z





Draw lines to match the pictures with the words.



children's programme

comedy

documentary

game show

sitcom

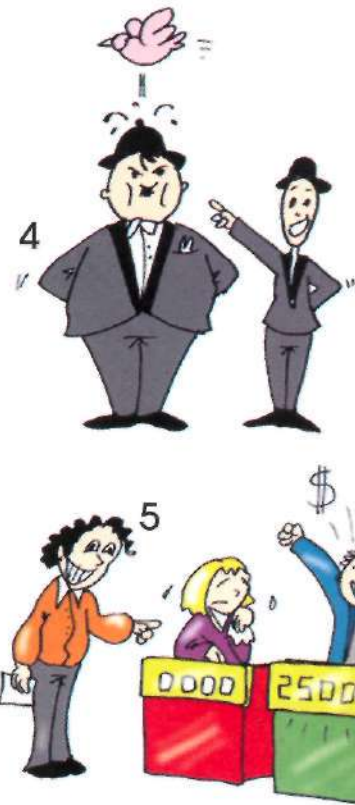

What's your favourite TV programme? Draw a picture.

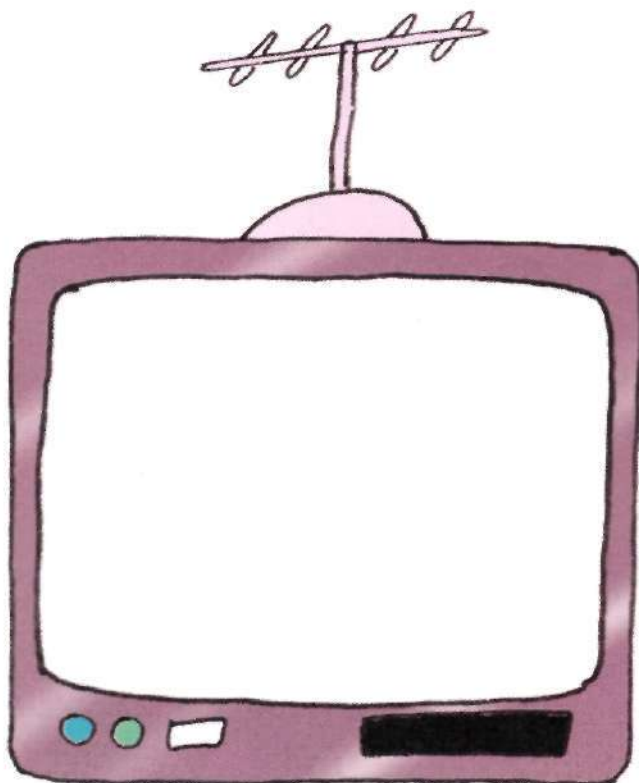

Draw lines to join the words

- | | |
|-----------|-----------|
| 1 TV | control |
| 2 talk | opera |
| 3 remote | fiction |
| 4 soap | programme |
| 5 science | guide |
| 6 radio | show |

D Look at the pictures and letters and write the words.









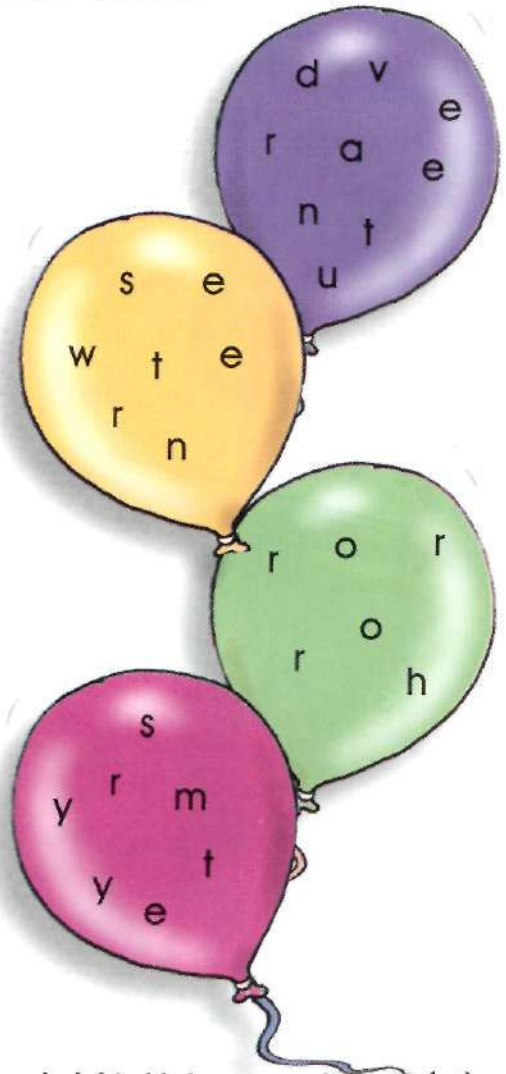

E What are Ben and Vicky going to watch tonight? Listen and tick (✓).

TV Guide Friday 20th March

Channel 1

Channel 2

Channel 3

6.00 CARTOON

6.25 CHILDREN'S PROGRAMME

7.00 TALK SHOW

7.20 SOAP OPERA

7.30 GAME SHOW

7.30 DOCUMENTARY (TIGERS)

9.10 COMEDY

9.10 FILM (SCIENCE FICTION)

8.50 THE NEWS



A

Look at the pictures and the letters and write the words.









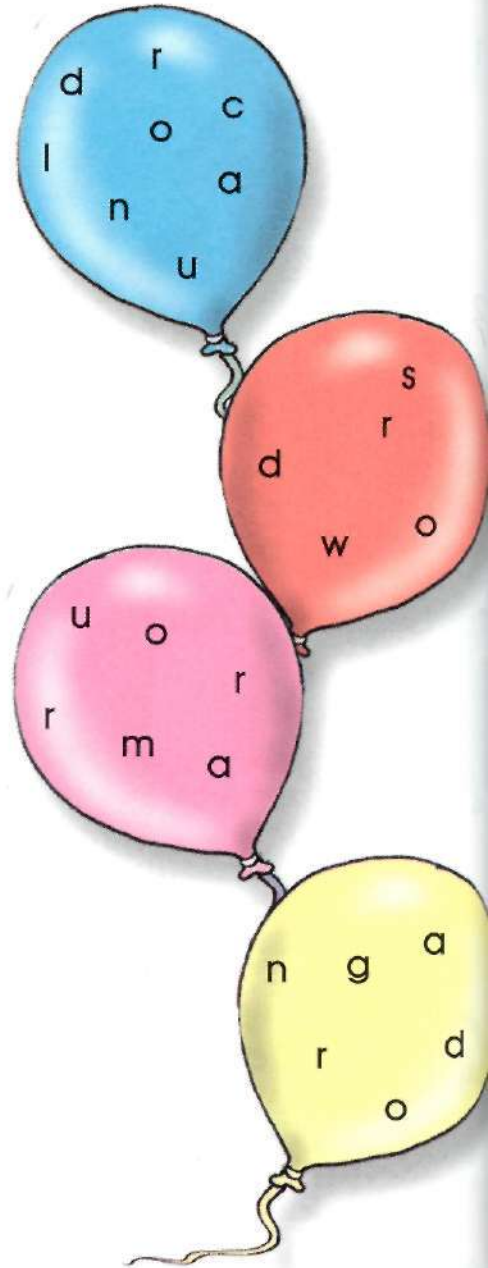

B

What are these? Write the words.



1 -----



2 -----



3 -----

C Read and draw.



1 a monster

2 a queen

3 a wizard

D Draw lines to match the words and the pictures.



E Listen, draw and colour.

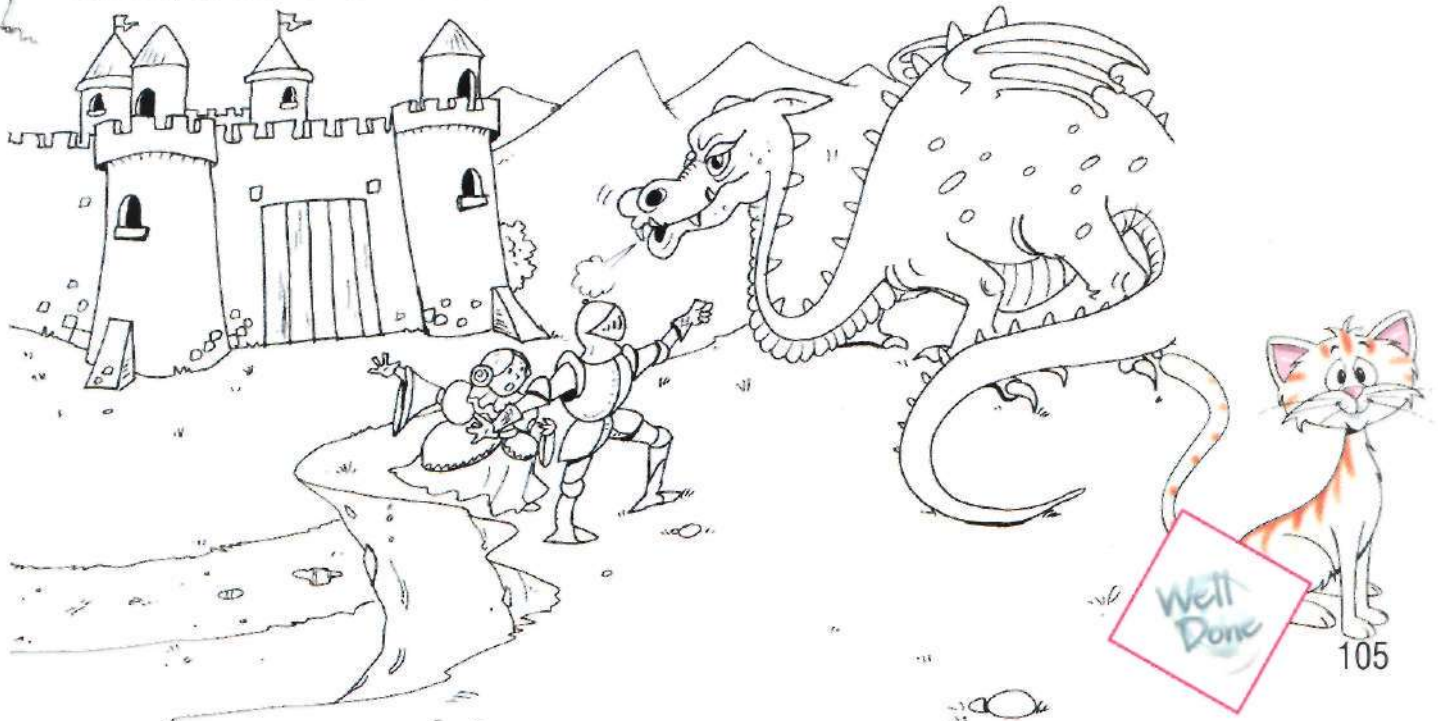

TEST YOUR VOCABULARY

- Translate into your own language.

THE BASICS

The Alphabet (p. 6-7)

alphabet
and
apple
ball
box
capital letters
cat
consonants
doll
egg
frog
glass
hat
igloo
jam
kite
lamb
letters
man
net
onion
pen
queen
ring
small letters
song
star
train
umbrella
van
vowels
watch
words

yacht

zoo

Numbers (p. 8-9)

a hundred
cardinals
divided by
eight
eighteen
eighth
eighty
eleven
eleventh
equals
even numbers
fifteen
fifth
fifty
finish
first
five
forty
four
fourteen
fourteenth
fourth
minus
nine
nineteen
ninety
ninth
numbers
odd numbers
one
ordinals
plus
second
seven

seventeen

seventh

seventy

six

sixteen

sixth

sixty

ten

tenth

third

thirteen

thirteenth

thirty

three

times

twelfth

twelve

twenty

twenty-one

two

Colours (p. 10-11)

black

brown

colours

dark blue

green

grey

light blue

orange

pink

purple

red

white

yellow

PEOPLE

Describing People

(p. 12-13)

bald
beard
blond(e)
brown
cheek
chin
curly
eye
eyebrow
eyelashes
eyelid
face
fair
forehead
freckles
fringe
ginger
grey
hair
jaw
lips
long
moustache
mouth
nose
nostril
pupil
short
straight
teeth
tongue
wavy
wrinkles

The Body (p. 14-15)

ankle
arm

armpit
back
body
calf
chest
elbow
finger
fingernail
foot
hand
head
heel
hip
knee
knuckle
leg
neck
palm
shin
shoulder
stomach
thigh
thumb
toenail
toes
waist
wrist

Clothes I (p. 16-17)

a pair of boots
a pair of high-heeled shoes
a pair of shoes
a pair of trousers
belt
blouse
bracelet
clothes
dress
dressing gown
earrings
glasses

handbag
hat
jacket
necklace
ring
shirt
skirt
suit
tie

Clothes II (p. 18-19)

a pair of dungarees
a pair of jeans
a pair of shorts
a pair of socks
a pair of trainers
a pair of wellingtons
cardigan
gloves
jumper
leggings
nightie
pyjamas
raincoat
scarf
sweatshirt
swimming trunks
tracksuit
T-shirt
vest

Ben and Vicky's Family (p. 20-21)

adult
aunt
baby
brother
child
children
cousin
dad

daughter
family
family tree
grandchildren
granddaughter
grandma
grandpa
grandparents
grandson
married
middle-aged person
mum
nephew
niece
parents
senior citizen
single
sister
son
teenager
toddler
uncle
young adult

HOME

On the Outside

(p. 22-23)

aerial
balcony
basement
block of flats
camper van
castle
cave
chimney
cottage
detached house
driveway
fence
floor

flowerbed
French window
front door
garage
garden
gate
greenhouse
ground floor
houseboat
igloo
letter box
lighthouse
patio
roof
semi-detached houses
skyscraper
step
tent
terraced houses
types of homes
villa
wall
wigwam
window
windowsill

In the Inside I

(p. 24-25)

armchair
bin
CD
CD player
chair
clock
coffee table
cooker
cupboard
curtain
cushion
dishwasher
door
fireplace

freezer
fridge
iron
ironing board
kettle
kitchen
lamp
living room
microwave
oven
photograph
picture
rug
sink
sofa
table
telephone
television/TV
toaster
vacuum cleaner
vase
video cassette
video recorder
washing machine

In the Inside II

(p. 26-27)

a bar of soap
a bottle of shampoo
a roll of toilet paper
a tube of toothpaste
bath
bathmat
bathroom
bed
bedroom
bedside table
blanket
bookcase
brush
carpet
chair

comb
desk
drawer
duvet
floor
mirror
pillow
plug
sheets
shower
sponge
tap
toilet
toothbrush
towel
wardrobe
washbasin

In the Garden (p. 28-29)

animals
bat
bee
bird
bird table
branch
butterfly
caterpillar
centipede
daffodil
fox
frog
garden table
grass
hedgehog
hosepipe
ladder
leaf
mole
nettle
paddling pool
path

plant pot
plants
rose
snail
things
tree house
tree trunk
trees
watering can
worm

FOOD

At the Supermarket (p. 30-31)

apple
aubergine
banana
broccoli
butter
cabbage
carrot
cauliflower
celery
cheese
cherries
chicken
coconut
cod
courgette
cream
cucumber
dairy products
fish
fruit
grapefruit
grapes
lamb
lemon
lettuce
margarine

meat
milk
mushroom
orange
peach
pear
pepper
pineapple
plum
potato
salmon
steak
strawberry
supermarket
tangerine
tomato
tuna
vegetables
watermelon
yogurt

In the Kitchen (p. 32-33)

bake
boil
bottle
bowl
breakfast
chop
cooking words
cup
dinner
flour
fork
fry
frying pan
glass
jar
jug
kitchen
knife
lunch

meals
mug
napkin
objects
olive oil
pepper
plate
pour
salt
saucepan
saucer
slice
spices
spoon
stir
straw
sugar
tablecloth
teapot
tray
vinegar

A Party (p. 34-35)

baked potato
barbecue
birthday cake
biscuits
burger
chips
coffee
coke
crisps
desserts
drinks
jelly
juice
lemonade
milkshake
party snacks
pasta
peanuts
pizza

popcorn
roast chicken
salad
sandwich
sweets
tea
water

TIME

What's the time?

(p. 36-37)

a.m.
clock
clock face
day
five past one
five to two
half past one
hands
midday
midnight
night
one o'clock
p.m.
(a) quarter past one
(a) quarter to two
ten past one
ten to two
time
twenty-five past one
twenty-five to two
twenty past one
twenty to two
watch

Days and Dates

(p. 38-39)

at night
date

days
eighteenth
fifteenth
fortnight
Friday
Monday
in the afternoon
in the evening
in the morning
nineteenth
Saturday
seventeenth
sixteenth
Sunday
thirtieth
thirty-first
Thursday
today
tomorrow
Tuesday
twentieth
twenty-eighth
twenty-fifth
twenty-first
twenty-fourth
twenty-ninth
twenty-second
twenty-seventh
twenty-sixth
twenty-third
Wednesday
week
weekdays
weekend
yesterday

The Year (p. 40-41)

April
Aquarius
Aries
August
Autumn

Cancer
Capricorn
century
decade
December
February
Gemini
January
July
June
leap year
Leo
Libra
March
May
millennium
months
November
October
Pisces
Sagittarius
Scorpio
seasons
September
signs of the zodiac
Spring
Summer
Taurus
time
Virgo
Winter
year

SCHOOL

My School (p. 42-43)

answer
Art
ask
changing rooms
circle

classroom
computer room
education
English
Geography
gym
hall
History
Languages
library
listen
look
Maths
Music
nursery school
Physical Education (PE)
play
playground
playing field
primary school
read
rectangle
school
Science
science laboratory
secondary school
shapes
sing
speak
square
staff room
subjects
think
triangle
verbs
write

Ben's Classroom (p. 44-45)

bell
board
bookcase

calculator
chalk
classroom
coloured pencils
computer
crayons
desk
drawing pin
globe
glue
lunch box
map
notebook
noticeboard
paint
paintbrush
paper
paper clip
pen
pencil
pencil case
pencil sharpener
poster
pupil
rubber
ruler
schoolbag
scissors
shelf
sticky tape
teacher
textbook

In the Computer Room (p. 46-47)

CD drive
CD recorder
CD-ROM
CD-ROM drive
computer room
disk drive
e-mail

floppy disk
keyboard
modem
mouse
mouse pad
plug
power switch
printer
printout
screen
speaker
tower
wire

The Music Room

(p. 48-49)

band
brass instruments
cello
choir
clarinet
cymbals
double bass
drums
flute
guitar
harmonica
harp
keyboard instruments
music room
music stand
musical instruments
note
percussion instruments
piano
recorder
saxophone
string instruments
synthesizer
tambourine
triangle
trombone

trumpet
violin
wind instruments
xylophone

Jobs (p. 50-51)

actor
actress
architect
artist
astronaut
builder
dancer
dentist
doctor
electrician
fire fighter
gardener
jobs
journalist
mechanic
musician
nurse
photographer
pilot
plumber
police officer
postal worker
sailor
secretary
singer
soldier
vet

ACTIVITIES

Indoor Hobbies

(p. 52-53)

autographs
board game

book
cards
cassette
chess
coins
collecting
comic
completing a jigsaw
computer game
construction blocks
doll's house
drawing a picture
hobbies
letter
listening
making models
music
painting
playing
postcard
racing car
radio
reading
stamps
teddy bear
toys
train set
video
watching
writing

At the Park (p. 54-55)

baseball
baseball bat
bench
bike
climbing frame
cycling
football
football pitch
go cycling
go on the climbing

frame
go on the roundabout
go on the see-saw
go on the slide
go on the swing
go rollerblading
go skateboarding
go skipping
goal
have a picnic
have a sandwich
have an ice cream
hopscotch
ice-cream van
juggler
litter bin
park
picnic table
play baseball
play football
play hopscotch
play in the sandpit
play tennis
playground
rollerblades
rollerblading
roundabout
sandpit
see-saw
skipping
skipping rope
slide
swing
tennis
tennis court
tennis racquet

At the Sports Centre (p. 56-57)

archery
armbands
arrow

badminton
bars
basketball
basketball court
basketball hoop
bat
beam
belt
bow
diving
diving board
do archery
do fencing
do gymnastics
do martial arts
fencing
foil
go diving
go ice-skating
go swimming
goggles
gymnastics
ice rink
ice-skates
ice-skating
ladder
martial arts
mask
net
play badminton
play basketball
play table tennis
practice mat
racquet
rings
shuttlecock
sports centre
suit
swimming
swimming cap
swimming pool
table tennis

table tennis table
target

At the Stadium (p. 58-59)

bronze medal
discus
finishing line
gold medal
high jump
hurdle
javelin
lane
long jump
podium
pole vault
relay
runner
seat
silver medal
spectator
stadium
starting line
ticket
track
weightlifting

Outdoor Activities (p. 60-61)

activities
boat
camping
camping stove
canoe
canoeing
canopy
compass
equipment
flippers
foam mat
hang-glider

hang-gliding
harness
helmet
hiking
hiking boots
horse riding
life jacket
map
mask
mountain bike
mountain biking
oars
outdoor
oxygen cylinder
paddle
paragliding
reins
rock climbing
rope
rowing
rucksack
saddle
sail
sailing
scuba diving
ski boots
ski poles
skiing
skis
sleeping bag
snowboard
snowboarding
tent
wet suit
windsurfer
windsurfing

ANIMALS

Pets (p. 62-63)

aquarium
beak
bones
budgie
cage
canary
cat basket
claw
dog
dried food
feather
features
fin
fish bowl
fur
goldfish
hamster
kennel
lizard
mouse
paw
pet food
pet homes
pets
rabbit
scales
seeds
tail
tortoise
wet food
whiskers
wing

On the Farm (p. 64-65)

ant
bee
billy goat

bull
calf
chick
chicken
cockerel
cow
crow
donkey
drive a tractor
duck
duckling
farm animals
farmer
feed chickens
foal
goat
goose
gosling
horse
kid
ladybird
lamb
make scarecrows
milk cows
owl
plant seeds
sheep
sheepdog
spider
swan
wasp
work in the fields

At the Zoo (p. 66-67)

alligator
antelope
antlers
bear
buffalo
camel
crocodile
deer

eagle
elephant
features
flamingo
giraffe
gorilla
hippopotamus
hooves
hump
kangaroo
koala
leopard
lion
mane
monkey
orang-utan
ostrich
panda
panther
parrot
rhinoceros
scorpion
snake
tiger
trunk
tusks
wild animals
wolf
zebra

Marine World (p. 68-69)

air
albatross
coral
crab
dolphin
eel
humpback whale
iceberg
jellyfish
killer whale
mussel

octopus
penguin
polar bear
ray
rocks
sea
sea urchin
seabed
seagull
seahorse
seal
seaweed
shark
shell
shipwreck
shrimp
starfish
swordfish
tuna fish
turtle
walrus

OUR WORLD

The Weather (p. 70-71)

blizzard
cloud
cloudy
cold
degrees Celsius
dry
foggy
freezing
hail
hailstorm
heatwave
hot
ice
icicle
lightning
mist

puddle
rain
raindrop
rainy
ray
sky
snow
snowflake
snowy
sun
sunny
temperature
thermometer
thunderstorm
weather
weather conditions
weather forecast
weather forecaster
wet
wind
windy

The Earth (p. 72-73)

Africa
Antarctica
Asia
Australia
climate
continental
continents
desert
earth
east
equator
Europe
mediterranean
mountain
north
North America
oceans
polar
south

South America
The Antarctic Ocean
The Arctic Ocean
The Atlantic Ocean
The Indian Ocean
The Pacific Ocean
tropical
tundra
west

The Landscape

(p. 74-75)

bay
beach
cliff
coast
drought
earthquake
flood
forest
forest fire
hurricane
island
lake
landscape
mountain range
natural disasters
natural features
peak
river
sand dunes
tidal wave
valley
volcanic eruption
waterfall

The Solar System

(p. 76-77)

Earth
Jupiter
Mars

Mercury
moon
Neptune
Pluto
Saturn
sun
Uranus
Venus

OUR TOWN

Transport (p. 78-79)

aeroplane
airport
ambulance
bus
bus station
car
car park
caravan
coach
fire engine
helicopter
hot-air balloon
hovercraft
hydrofoil
lorry
motorbike
police car
port
ship
speed boat
train
tram
transport
underground train

On the Road (p. 80-81)

bonnet
boot
bridge

bus stop
corner
engine
lamp post
lane
motorway
number plate
pavement
pedestrian crossing
petrol pump
petrol station
road
road markings
road sign
street
telephone box
traffic light
traffic warden

Main Street (p. 82-83)

baker
baker's
bank
buildings
butcher
butcher's
cafe
chemist
chemist's
cinema
city
communities
greengrocer
greengrocer's
gym
hospital
hotel
librarian
library
newsagent
newsagent's
office building

post office
refuse collector
shopping centre
shops
supermarket
theatre
town
village

In a Shopping Centre (p. 84-85)

bookshop
card shop
CD shop
clothes shop
escalator
fast food restaurant
florist's
hairdresser's
information desk
jeweller's
lift
optician's
pet shop
phone booth
restaurant
shoe shop
toy shop
travel agent's
video shop

At the Clinic (p. 86-87)

bandage
blood
bruise
cast
clinic
cut
dentist
doctor
earache
first aid kit

headache
injection
medical instruments
medical problems
medical words
medicine
nurse
patient
people
pill
prescription
receptionist
sling
sore throat
sticking plaster
stitches
stomachache
stretcher
surgeon
temperature
thermometer
toothache
wheelchair
X-ray

WORDS

Opposites (p. 88-89)

back
bad
big
blunt
bottom
cheap
clean
closed
cold
dark
different
difficult
dirty

easy
empty
expensive
false
far
fast
fat
front
full
good
hard
heavy
here
high
hot
left
light
long
low
modern
near
new
noisy
old
old-fashioned
open
quiet
right
rough
same
sharp
short
slow
small
smooth
soft
sour
strong
sweet
there
thin
top

true
weak
wrong
young

At the Playground

(p. 90-91)

above
at the bottom of
at the top of
behind
below
between
box
climbing frame
in
in front of
monkey frame
next to
on
out
playground
rubbish bin
slide
swing
under
wall

In the Maze (p. 92-93)

across
along
arch
bench
bridge
down
entrance
exit
fountain
hill
into
lake

maze
onto
out of
over
past
round
statue
through
towards
up
well

A Summer Camp

(p. 94-95)

brush
clean
dream
drink
eat
get dressed
get up
hang up
lift
make the bed
mop
open
put away
set the table
sit down
sleep
stand up
stretch
sweep
tie up
turn off
turn on
wake up
wash
wash up
yawn

A School Fair (p. 96-97)

buy
carry
catch
chase
climb
cycle
dig
drive
fall
fight
give
hide
hit
hug
kick
kiss
laugh
push
throw
water
wave
whisper

FUN

At the Beach (p. 98-99)

armbands
beach
beach ball
beach mat
beach umbrella
beach volley
bucket
cap
cooler
deckchair
diving mask
flippers
goggles
lifeguard

pebbles
rock
rubber dinghy
rubber ring
sand
sandcastle
shell
snorkel
spade
sunglasses
sunscreen
surfboard
waves

Leisure Time

(p. 100-101)

audience
ballet
big wheel
candyfloss
cinema
conductor
dancer
dinosaur
dodgems
exhibit
exhibition
fans
film
funfair
information
merry-go-round
museum
natural science museum
orchestra
painting
play
roller-coaster
screen
sculpture
sports event

stage
team
theatre
usher
zoo
zookeeper

Home Entertainment (p. 102-103)

adventure
cartoon
children's programme
comedy
documentary
films
game show
horror
interview
music
mystery
radio
radio programmes
remote control
romance
science fiction
sitcom
soap opera
talk show
the news
TV guide
TV programmes
western

Fairy Tales (p. 104-105)

alien
armour
broomstick
castle
cauldron
characters
crown
dragon

fairy
genie
ghost
giant
king
knight
lamp
mermaid
moat
monster
pirate
prince
princess
queen
shield
skeleton
spaceship
sword
things
treasure
vampire
wand
witch
wizard

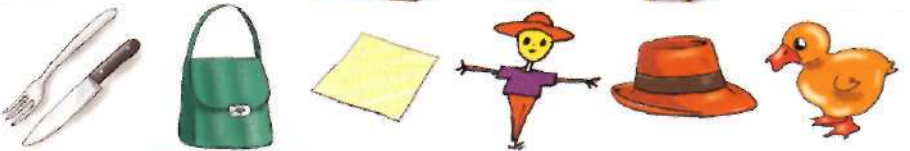



IMPORTED FROM THE EU
BY CENTERCOM LTD

activity book

THE EXPRESS PICTURE DICTIONARY

for young learners

The Express Picture Dictionary for young learners is a beautifully illustrated, fun-to-use dictionary, designed to present and consolidate basic vocabulary. It can be used both in class as supplementary material for young learners or beginners and at home as a self study kit.

Key Features

- ◆ 12 topic-based modules, consisting of 3-5 units each, relate to the home, school and everyday environments of students.
- ◆ Clear and lively presentation of vocabulary on fully illustrated double page spreads.
- ◆ Emphasis on everyday words, collocations and expressions to help students develop a feeling for the English language.
- ◆ Oral tasks and games to motivate students to practise pronunciation and to use the words in context.
- ◆ 24 topic-related and fun-to-learn traditional and original songs.
- ◆ Wide variety of exercises, listening tasks, puzzles and wordsearches to stimulate students' imagination and consolidate the vocabulary presented.

Components

- ◆ The Express Picture Dictionary for young learners
- ◆ The Express Picture Dictionary for young learners Activity Book
- ◆ The Express Picture Dictionary for young learners Activity Book (Teacher's Book)
- ◆ The Express Picture Dictionary for young learners Cassettes/Audio CDs
- ◆ The Express Picture Dictionary for young learners Activity Book Cassette/Audio CD



Express Publishing

The Express Picture Dictionary
Activity Book
ISBN 1-84216-610-7

